

---

**Fire Alarm Control Panel**  
**NFS-640**  
**Programming Manual**

# Fire Alarm System Limitations

*While a fire alarm system may lower insurance rates, it is not a substitute for fire insurance!*

**An automatic fire alarm system**—typically made up of smoke detectors, heat detectors, manual pull stations, audible warning devices, and a fire alarm control panel with remote notification capability—can provide early warning of a developing fire. Such a system, however, does not assure protection against property damage or loss of life resulting from a fire.

The Manufacturer recommends that smoke and/or heat detectors be located throughout a protected premise following the recommendations of the current edition of the National Fire Protection Association Standard 72-1999 (NFPA 72-1999), manufacturer's recommendations, State and local codes, and the recommendations contained in the Guide for Proper Use of System Smoke Detectors, which is made available at no charge to all installing dealers. A study by the Federal Emergency Management Agency (an agency of the United States government) indicated that smoke detectors may not go off in as many as 35% of all fires. While fire alarm systems are designed to provide early warning against fire, they do not guarantee warning or protection against fire. A fire alarm system may not provide timely or adequate warning, or simply may not function, for a variety of reasons:

**Smoke detectors** may not sense fire where smoke cannot reach the detectors such as in chimneys, in or behind walls, on roofs, or on the other side of closed doors. Smoke detectors also may not sense a fire on another level or floor of a building. A second-floor detector, for example, may not sense a first-floor or basement fire.

**Particles of combustion or "smoke"** from a developing fire may not reach the sensing chambers of smoke detectors because:

- Barriers such as closed or partially closed doors, walls, or chimneys may inhibit particle or smoke flow.
- Smoke particles may become "cold," stratify, and not reach the ceiling or upper walls where detectors are located.
- Smoke particles may be blown away from detectors by air outlets.
- Smoke particles may be drawn into air returns before reaching the detector.

The amount of "smoke" present may be insufficient to alarm smoke detectors. Smoke detectors are designed to alarm at various levels of smoke density. If such density levels are not created by a developing fire at the location of detectors, the detectors will not go into alarm.

Smoke detectors, even when working properly, have sensing limitations. Detectors that have photoelectronic sensing chambers tend to detect smoldering fires better than flaming fires, which have little visible smoke. Detectors that have ionizing-type sensing chambers tend to detect fast-flaming fires better than smoldering fires. Because fires develop in different ways and are often unpredictable in their growth, neither type of detector is necessarily best and a given type of detector may not provide adequate warning of a fire.

Smoke detectors cannot be expected to provide adequate warning of fires caused by arson, children playing with matches (especially in bedrooms), smoking in bed, and violent explosions (caused by escaping gas, improper storage of flammable materials, etc.).

**Heat detectors** do not sense particles of combustion and alarm only when heat on their sensors increases at a predetermined rate or reaches a predetermined level. Rate-of-rise heat detectors may be subject to reduced sensitivity over time. For this reason, the rate-of-rise feature of each detector should be tested at least once per year by a qualified fire protection specialist. Heat detectors are designed to protect property, not life.

**IMPORTANT! Smoke detectors** must be installed in the same room as the control panel and in rooms used by the system for the connection of alarm transmission wiring, communications, signaling, and/or power. If detectors are not so located, a developing fire may damage the alarm system, crippling its ability to report a fire.

**Audible warning devices** such as bells may not alert people if these devices are located on the other side of closed or partly open doors or are located on another floor of a building. Any warning device may fail to alert people with a disability or those who have recently consumed drugs, alcohol or medication. Please note that:

- Strobes can, under certain circumstances, cause seizures in people with conditions such as epilepsy.
- Studies have shown that certain people, even when they hear a fire alarm signal, do not respond or comprehend the meaning of the signal. It is the property owner's responsibility to conduct fire drills and other training exercise to make people aware of fire alarm signals and instruct them on the proper reaction to alarm signals.
- In rare instances, the sounding of a warning device can cause temporary or permanent hearing loss.

**A fire alarm system** will not operate without any electrical power. If AC power fails, the system will operate from standby batteries only for a specified time and only if the batteries have been properly maintained and replaced regularly.

**Equipment used in the system** may not be technically compatible with the control panel. It is essential to use only equipment listed for service with your control panel.

**Telephone lines** needed to transmit alarm signals from a premise to a central monitoring station may be out of service or temporarily disabled. For added protection against telephone line failure, backup radio transmission systems are recommended.

**The most common cause** of fire alarm malfunction is inadequate maintenance. To keep the entire fire alarm system in excellent working order, ongoing maintenance is required per the manufacturer's recommendations, and UL and NFPA standards. At a minimum, the requirements of Chapter 7 of NFPA 72-1999 shall be followed. Environments with large amounts of dust, dirt or high air velocity require more frequent maintenance. A maintenance agreement should be arranged through the local manufacturer's representative. Maintenance should be scheduled monthly or as required by National and/or local fire codes and should be performed by authorized professional fire alarm installers only. Adequate written records of all inspections should be kept.

# Installation Precautions

*Adherence to the following will aid in problem-free installation with long-term reliability:*

**WARNING - Several different sources of power can be connected to the fire alarm control panel.** Disconnect all sources of power before servicing. The control unit and associated equipment may be damaged by removing and/or inserting cards, modules, or interconnecting cables while the unit is energized. Do not attempt to install, service, or operate this unit until this manual is read and understood.

**CAUTION - System Reacceptance Test after Software Changes.** To ensure proper system operation, this product must be tested in accordance with NFPA 72-1999 Chapter 7 after any programming operation or change in site-specific software. Reacceptance testing is required after any change, addition or deletion of system components, or after any modification, repair or adjustment to system hardware or wiring.

All components, circuits, system operations, or software functions known to be affected by a change must be 100% tested. In addition, to ensure that other operations are not inadvertently affected, at least 10% of initiating devices that are not directly affected by the change, up to a maximum of 50 devices, must also be tested and proper system operation verified.

**This system** meets NFPA requirements for operation at 0°C to 49°C (32°F to 120°F) and at a relative humidity (noncondensing) of 85% at 30°C (86°F) per NFPA, and 93% ± 2% at 32°C ± 2°C (89.6°F ± 1.1°F) per ULC. However, the useful life of the system's standby batteries and the electronic components may be adversely affected by extreme temperature ranges and humidity. Therefore, it is recommended that this system and all peripherals be installed in an environment with a nominal room temperature of 15-27° C/60-80° F.

**Verify that wire sizes are adequate** for all initiating and indicating device loops. Most devices cannot tolerate more than a 10% I.R. drop from the specified device voltage.

**Like all solid state electronic devices,** this system may operate erratically or can be damaged when subjected to lightning-induced transients. Although no system is completely immune from lightning transients and interferences, proper grounding will reduce susceptibility. Overhead or outside aerial wiring is not recommended, due to an increased susceptibility to nearby lightning strikes. Consult with the Technical Services Department if any problems are anticipated or encountered.

**Disconnect AC power and batteries** prior to removing or inserting circuit boards. Failure to do so can damage circuits.

**Remove all electronic assemblies** prior to any drilling, filing, reaming, or punching of the enclosure. When possible, make all cable entries from the sides or rear. Before making modifications, verify that they will not interfere with battery, transformer, and printed circuit board location.

**Do not tighten screw terminals** more than 9 in-lbs. Over-tightening may damage threads, resulting in reduced terminal contact pressure and difficulty with screw terminal removal.

**Though designed to last many years,** system components can fail at any time. This system contains static-sensitive components. Always ground yourself with a proper wrist strap before handling any circuits so that static charges are removed from the body. Use static-suppressive packaging to protect electronic assemblies removed from the unit.

**Follow the instructions** in the installation, operating, and programming manuals. These instructions must be followed to avoid damage to the control panel and associated equipment. FACP operation and reliability depend upon proper installation by authorized personnel.

Precau-L-10-2003.fm

## FCC Warning

**WARNING:** This equipment generates, uses, and can radiate radio frequency energy and if not installed and used in accordance with the instruction manual, may cause interference to radio communications. It has been tested and found to comply with the limits for class A computing device pursuant to Subpart B of Part 15 of FCC Rules, which is designed to provide reasonable protection against such interference when operated in a commercial environment. Operation of this equipment in a residential area is likely to cause interference, in which case the user will be required to correct the interference at his own expense.

## Canadian Requirements

This digital apparatus does not exceed the Class A limits for radiation noise emissions from digital apparatus set out in the Radio Interference Regulations of the Canadian Department of Communications.

Le present appareil numerique n'emet pas de bruits radioelectriques depassant les limites applicables aux appareils numeriques de la classe A prescrites dans le Reglement sur le brouillage radioelectrique edicte par le ministere des Communications du Canada.

Acclimate Plus™, AWACS™, HARSH™, NOTI-FIRE-NET™, ONYX™, and VeriFire™ are trademarks, and FlashScan®, UniNet®, and VIEW® are registered trademarks of NOTIFIER. NION™ is a trademark of NIS. NIS™ and Notifier Integrated Systems™ are trademarks and NOTIFIER® is a registered trademark of Fire-Lite Alarms, Inc. Echelon® is a registered trademark and LonWorks™ is a trademark of Echelon Corporation. ARCNET® is a registered trademark of Datapoint Corporation. Microsoft® and Windows® are registered trademarks of the Microsoft Corporation. LEXAN® is a registered trademark of GE Plastics, a subsidiary of General Electric Company.

# Documentation Feedback

Your feedback helps us keep our documentation up-to-date and accurate. If you have any comments or suggestions about our online Help or printed manuals, you can email us.

Please include the following information:

- Product name and version number (if applicable)
- Printed manual or online Help
- Topic Title (for online Help)
- Page number (for printed manual)
- Brief description of content you think should be improved or corrected
- Your suggestion for how to correct/improve documentation

Send email messages to:

**[TechPubs@fla-whq.com](mailto:TechPubs@fla-whq.com)**

Please note this email address is for documentation feedback only. If you have any technical issues, please contact Technical Services.

# Contents

## About This Manual

Cautions and Warnings .....	9
Typographic Conventions.....	9
Supplemental Information .....	10
Shortcuts to Operating Functions.....	11

## 1. Getting Started

Introduction to the Control Panel.....	12
Features .....	12
Selecting a Programming Method .....	13
How to Enter a Password .....	13

## 2. Program Change

What is Program Change? .....	14
In This Section .....	14
How to Enter Program Change .....	15
How to Use the Basic Program.....	15
How to Clear Memory (0=CLR).....	16
How to Autoprogram the Control Panel (1=AUTO) .....	16
Purpose .....	16
Create a New Program for the Control Panel .....	17
How to Add a Device to the Program.....	18
How to Remove a Device from the Program .....	18
How to Change Autoprogram Default Values .....	20
How to Modify or Delete a Point (2=POINT) .....	21
How to Modify an Addressable Detector Point.....	22
How to Modify an Addressable Monitor Module Point.....	23
Monitor Module Default Zone Assignments.....	23
How to Modify an Addressable Control Module Point.....	24
How to Modify NAC and Panel Circuit Points .....	25
How to Change a Password (3=PASSWD) .....	26
How to Create a System Message (4=MESSAGE).....	27
How to Create a Custom Zone Label (5=ZONE) .....	28
How to Program Special Zones (6=SPL FUNCT) .....	29
What are Special Zones? .....	29
How to Select Special Zones.....	30
How to Change Global System Functions (7=SYSTEM) .....	32
Global System Functions.....	32
Annunciator Options.....	33
ACS Selection Group Example .....	33
Annunciation Points .....	34
ACS Selection Group A: .....	35
ACS Selection Group B: .....	35
ACS Selection Group C (SLC #1, Modules 1-64): .....	36
ACS Selection Group D (SLC #2, Modules 1-64): .....	36
ACS Selection Group E (SLC #1, Modules 65-128): .....	36
ACS Selection Group F (SLC #2, Modules 65-128): .....	36
ACS Selection Group G (SLC #1 and #2, Modules 129-159): .....	37
ACS Selection Group H (SLC #1): .....	37
ACS Selection Group I (SLC #2): .....	37
ACS Selection Group J (SLC #1): .....	38
ACS Selection Group K (SLC #2): .....	38
ACS Selection Group L (SLC #1 and #2): .....	38

ACS Selection Group M: .....	39
ACS Selection Group N.....	40
ACS Selection Group O.....	40
How to Check the Program for Errors (8=CHECK PRG) .....	41
<b>How to Use the Network Program</b> .....	42
How to Select the Network Program Options .....	42
<b>How to Use the Utility Program</b> .....	43
Utility Program Options .....	43
How to Select Utility Program Options .....	43
<b>How to Use FlashScan Poll</b> .....	44
Baud Rate of Serial Ports .....	45

### 3. Status Change

<b>What is Status Change?</b> .....	46
<b>How to Enter Status Change</b> .....	46
Status Change Options .....	46
<b>How to Disable or Enable a Point</b> .....	47
<b>How to Change Sensitivity for a Detector</b> .....	48
How to Select a Detector.....	48
How to Use the Detector Sensitivity Screen.....	48
<b>How to Clear Alarm Verification Counters</b> .....	49
<b>How to Clear the History Buffer</b> .....	49
<b>How to Set the System Time and Date</b> .....	49
<b>How to Do a Walk Test</b> .....	50
Basic Walk Test .....	50
Advanced Walk Test.....	51
Walk Test Activation Indications.....	51
Viewing Walk Test Results.....	52

### Appendix A: Releasing Applications

<b>What are Releasing Zones?</b> .....	53
<b>NFPA Releasing Applications</b> .....	53
<b>How to Program a Releasing Zone</b> .....	54
How to Program a Delay Timer .....	54
How to Program an Abort Switch.....	54
Definition of Abort Switches.....	54
How an Abort Switch Works.....	55
Programming a ULI Abort Switch.....	56
Programming an IRI Abort Switch.....	57
Programming an NYC Abort Switch.....	59
Programming an AHJ Abort Switch.....	61
Using Cross Zones .....	62
Purpose of Cross Zones .....	62
How Cross Zones Work.....	62
How to Program a Soak Timer (NFPA 16 Applications Only) .....	64
Using Type Codes for Releasing Zones.....	65
How to Program an Abort Switch.....	66
How to Program a Manual Release Switch .....	67
How to Program a Manual Release Delay Switch.....	68
How to Program a Second Shot Switch.....	70
How to Program a Release End Bell Circuit .....	71
How to Program a ULC Release Circuit .....	72
How to Program a Release Circuit for an Output Circuit.....	73
How to Program a Release Form-C Circuit.....	74
How to Program a Release Audible Circuit.....	75

How to Program an Instant Release Circuit .....	76
How to Program a Release Code Bell Circuit .....	77
<b>Initiating Devices</b> .....	78
<b>Warning Sounders</b> .....	78
<b>Auxiliary Control Functions</b> .....	78
<b>ACS Annunciation</b> .....	78

## **Appendix B: Special Zone Outputs**

<b>Presignal and Positive Alarm Sequence (PAS)</b> .....	80
What is Presignal and PAS? .....	80
Purpose .....	80
Notes on using F0 .....	80
Restrictions on using F0 .....	80
Selecting Presignal and PAS Outputs .....	81
Presignal .....	81
Positive Alarm Sequence (PAS) .....	81
<b>Time Control Zones</b> .....	82
<b>Coding Functions for NACS and Panel Circuits</b> .....	82

## **Appendix C: AWACS™ Applications**

<b>AWACS Overview</b> .....	84
<b>AWACS Features</b> .....	84
Drift Compensation and Smoothing .....	84
Maintenance Warnings – Three Levels .....	85
Self-Optimizing Pre-Alarm .....	86
Detector Sensitivity .....	86
Cooperative Multi-Detector Sensing .....	87
<b>Pre-Alarm</b> .....	88
Definition .....	88
Alert Level .....	88
Alert Functions .....	88
Example of an Alert Level .....	88
Action Level .....	88
Action Functions .....	88
How to Select a Pre-Alarm Level .....	89
<b>Detector Sensitivity Settings</b> .....	90
How to Select Pre-Alarm and Alarm Sensitivity .....	90
How to Test Detectors Set Below 0.50% Obscuration per Foot .....	91
<b>Detector Maintenance Features</b> .....	92
Overview .....	92
How to Access Detector Maintenance Information .....	92
View Detector Maintenance for a Detector .....	92
Print a Detector Maintenance Report .....	93
How to Interpret a Detector Status Display or Maintenance Report .....	93

## **Appendix D: CBE (Control-By-Event)**

<b>Description</b> .....	95
<b>Input and Outputs</b> .....	95
<b>Equations</b> .....	95
<b>Equation Entry</b> .....	96
Logic Functions .....	96
The “AND” Operator .....	96
The “OR” Operator .....	96
The “NOT” Operator .....	96
The “ONLY1” Operator .....	96
The “ANY2” Operator .....	96

The “ANY3” Operator .....	96
The “XZONE” Operator .....	96
The “RANGE” Operator .....	96
Equation Syntax Example .....	97
Evaluating an Equation .....	97
Argument Entries .....	98
Time Delay Functions .....	98
The “DEL” Operator .....	98
The “SDEL” Operator .....	98
<b>CBE Example</b> .....	<b>99</b>
<b>Appendix E: Detector Initialization</b>	
<b>Overview</b> .....	101
<b>System Testing and Detector Initialization</b> .....	101
<b>How to Replace a Detector</b> .....	101
<b>How to Manually Initialize a Detector</b> .....	102
<b>Appendix F: Type Codes</b>	
<b>What are Type Codes?</b> .....	103
<b>How to Select a Type Code</b> .....	103
<b>In this Appendix</b> .....	103
<b>Type Codes for Input Devices</b> .....	104
Overview .....	104
Type Codes for Intelligent Detectors .....	104
Type Codes for Monitor Modules .....	105
<b>Type Codes for Output Devices</b> .....	106
Overview .....	106
Type Codes for Control Modules .....	106
NAC and Panel Circuit Type Codes .....	107
<b>Glossary</b> .....	<b>109</b>



# About This Manual

## Cautions and Warnings

The following graphics appear in the manual to indicate a caution or a warning.



**CAUTION:** Information about procedures that could cause programming errors, runtime errors, or equipment damage.



**WARNING:** Information about procedures that could cause irreversible damage to the control panel, irreversible loss of programming data or personal injury.

## Typographic Conventions

This manual uses the following conventions as listed below:

When you see	Specifies	Example
text in small caps	the text as it appears in the LCD display or on the control panel	MARCH TIME is a selection that appears in the LCD display; or Press the ENTER key
text in quotes	a reference to a section or a LCD menu screen	“Status Change” specifies the Status Change section or menu screen
bold text	In body text, a number or character that you enter	Press <b>1</b> ; means to press the number “1” on the keypad
italic text	a specific document	<i>NFS-640 Installation Manual</i>
a graphic of the key	In a graphic, a key as it appears on the control panel	Press  means to press the Escape key

**Table 1 Typographic Conventions in this Manual**

## Supplemental Information

The table below provides a list of documents referenced in this manual, as well as documents for selected other compatible devices. The document series chart (DOC-NOT) provides the current document revision. A copy of this document is included in every shipment.

<b>Compatible Conventional Devices (Non-addressable)</b>	<b>Document Number</b>
Device Compatibility Document	15378
<b>Fire Alarm Control Panel (FACP) and Main Power Supply Installation</b>	<b>Document Number</b>
NFS-640 Installation, Operations, and Programming Manuals	51332, 51334, 51333
Voice Alarm System Manual	51252
SLC Wiring Manual	51253
Note: For individual SLC Devices, refer to the <i>SLC Wiring Manual</i>	
<b>Off-line Programming Utility</b>	<b>Document Number</b>
VeriFire™ Tools CD help file	VERIFIRE-TCDD
Veri•Fire Medium Systems Help File	VERIFIRE-CD
<b>Cabinets &amp; Chassis</b>	<b>Document Number</b>
CAB-3/CAB-4 Series Cabinet Installation Document	15330
Battery/Peripherals Enclosure Installation Document	50295
<b>Power Supplies, Auxiliary Power Supplies &amp; Battery Chargers</b>	<b>Document Number</b>
ACPS-2406 Installation Manual	51304
APS-6R Instruction Manual	50702
CHG-120 Battery Charger Manual	50641
FCPS-24 Field Charger/Power Supply Manual	50059
<b>Networking</b>	<b>Document Number</b>
Noti•Fire•Net Manual, Network Version 4.0 & Higher	51584
NCM-W/F Installation Document	51533
NCS Network Control Station Manual, Network Version 4.0 & Higher	51658
<b>System Components</b>	<b>Document Number</b>
Annunciator Control System Manual	15842
Annunciator Fixed Module Manual	15048
AFM-16A Annunciator Fixed Module Manual	15207
ACM-8R Annunciator Control Module Manual	15342
LCD-80 Manual	15037
LCD-80TM Manual	51082
LDM Series Lamp Driver Annunciator Manual	15885
NCA Network Control Annunciator Manual	51482
SCS Smoke Control Manual (Smoke and HVAC Control Station)	15712
RPT-485W/RPT-485WF EIA-485 Annunciator Loop Repeater Manual	15640
DPI-232 Direct Panel Interface Manual	51499
TM-4 Installation Document (Reverse Polarity Transmitter)	51490
UDACT Manual (Universal Digital Alarm Communicator/Transmitter)	50050
ACT-2 Installation Document	51118
VEC 25/50 Manual	50686
RM-1 Series Remote Microphone Installation Document	51138

RA400Z Remote LED Annunciator Installation Document	I56-508
RFX Wireless Interface Manual	51012
UZC-256 Universal Zone Coder Manual	15216
UZC-256 Programming Manual	15976
XP Transponder Manual	15888
XP10-M Installation Document	I56-1803
XP5 Series Manual	50786
XP6-C Installation Document	I56-1805
XP6-MA Installation Document	I56-1806
XP6-R Installation Document	I56-1804
XPIQ Audio Transponder Manual	51013

**Table 2 Supplemental Documentation**

## Shortcuts to Operating Functions



To the left of each program function, you'll find a keypad shortcut, which contains a series of keypad entries required to access the program function. All shortcuts start with the control panel in normal operation.



For example, the keypad shortcut to the left shows how to enter the Read Status function with the control panel in normal operation.

# 1. Getting Started

## Introduction to the Control Panel

The NFS-640 is an intelligent, field-programmable Fire Alarm Control Panel. Field-programming the control panel lets you customize the fire alarm system by selecting and setting program options for intelligent/addressable detectors and modules, Panel Circuits, and Notification Appliance Circuits (NACs).

This manual provides information for programming using the NFS-640 keypad connected to the control panel. VeriFire™ Tools must be used for programming if no keypad is used, or if an NCA (Network Control Annunciator) is used as the keypad in either a network or standalone application. Refer to VeriFire™ Tools for information on programming without the NFS-640 keypad, and the *NFS-640 Installation Manual* and *NCA Manual* for installation information.

For details on control panel operation, refer to the *NFS-640 Operations Manual*.

## Features

Programming features include the following:

- Ease-of-use – Field program the control panel without needing special software skills.
- Autoprogram option – Automatically detects newly installed, addressable devices, allowing quicker installation.
- Local programming – program directly from the control panel keypad to reduce installation time.
- PC programming – input long data entry programming information on a PC; transfer programming data between a PC and the control panel using VeriFire™ Tools programming utility.
- Security – use passwords to control access to the control panel and protect memory.
- 80-Character (2x40) Liquid Crystal Display – view programming and device information on the control panel.

## Selecting a Programming Method

The NFS-640 provides two methods for field-programming the control panel:

- Using the built-in “Program Change” interface
- The VeriFire™ Tools Programming Utility

The benefits of each method are listed below:

Programming method	Benefits	Refer to
Program Change	Speed and convenience of putting the control panel on line quickly (using the Autoprogram function) and changing programming information.	Section “2. Program Change” on page 14
VeriFire™ Tools Programming Utility	Efficient means of creating and editing programs that require a lot of data entry.	Product documentation & Software help file

## How to Enter a Password

The control panel provides two types of selectable passwords:

- Program Change
- Status Change

Listed below are uses and the factory-setting for each password type:

Password type	Use to	Factory Setting
Program Change (high level)	Enter Program Change option to program essential control panel functions, including basic system functions and utility options.	<b>00000</b>
Status Change (low level)	Enter Status Change option to program minor functions.	<b>11111</b>

**Table 3 Programming Passwords**

From the “SYSTEM NORMAL” screen: Press ENTER, press **1** (the password screen will display). Enter a password, then press ENTER:

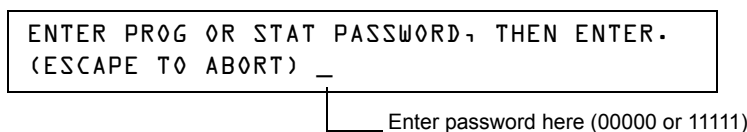

**Figure 1 Password Screen**

In Program Change or Status Change, the control panel does the following:

- Activates the System Trouble relay
- Shuts off the panel sounder
- Flashes the SYSTEM TROUBLE LED, which continues to flash while programming

For security purposes, you can change your passwords. To do so, follow the instructions in “How to Change a Password (3=passwd)” on page 26.

**Note:** The **Read Status** selection, which does not require a program password, is covered in the *NFS-640 Operations Manual*.

**Note:** The NFS-640 continues to monitor and report alarms in programming mode, except in autoprogramming.

## 2. Program Change

### What is Program Change?

Program Change is the programming level that lets you change the essential control panel functions, such as point programming, changing passwords, changing system functions. Included are four selections: Basic Program, Network, FlashScan Poll, and Utility Program.

The structure of the Program Change option is shown below:

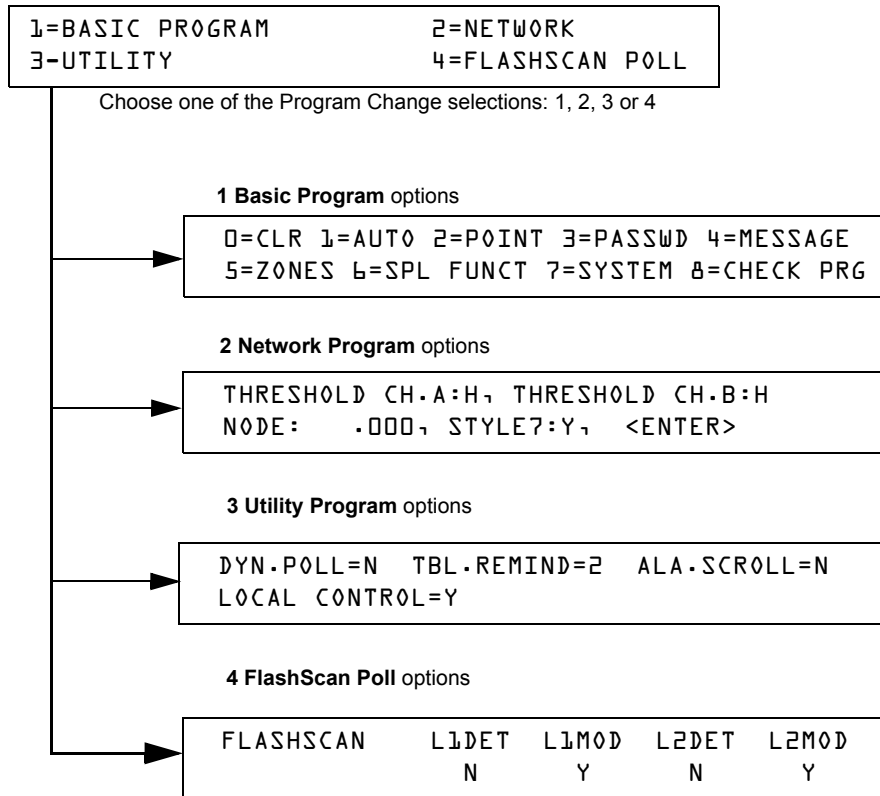

Figure 2 Program Change Selections

### In This Section

This section contains instructions and sample screens for using the Program Change selections:

- **Basic Program** The Basic Program lets you program essential functions, such as clearing the program, Autoprogramming the system, programming points, and setting system functions. Refer to “How to Use the Basic Program” on page 15.
- **Network Program** The Network Program allows programming of network channel thresholds, network node number, and wiring style. “How to Use the Network Program” on page 42.
- **Utility Program** The Utility Program screen provides selections for Dynamic Polling of the SLC(s), selecting a Trouble Reminder per NFPA, and enabling or disabling local control of the ACKNOWLEDGE/SCROLL DISPLAY, SIGNAL SILENCE, and SYSTEM RESET keys. Refer to “How to Use the Utility Program” on page 43.
- **FlashScan Poll** The FlashScan Poll screen provides the option for selecting between CLIP (Classic Loop Interface Poll) and FlashScan Poll. Refer to “How to Use FlashScan Poll” on page 44.

## How to Enter Program Change

To enter Program Change, follow these steps:

1. At the “SYSTEM NORMAL” screen, press the ENTER key. The control panel displays the “Entry” screen, as shown below:

```

1=PROGRAMMING          2=READ STATUS ENTRY
(ESCAPE TO ABORT)

```

2. At the “Entry” screen, press the **1** key. The control panel displays the “Enter Password” screen as shown below:

```

ENTER PROG OR STAT PASSWORD, THEN ENTER.
(ESCAPE TO ABORT) _

```

3. Enter your Program Change password (See “How to Enter a Password” on page 13). The control panel displays the “Program Change Selection” screen, as shown below:

```

1=BASIC PROGRAM          2=NETWORK
3=UTILITY                4=FLASHSCAN POLL

```

4. Select a Program Change selection: **1, 2, 3 or 4.**

## How to Use the Basic Program

From the “Program Change Selection” screen, press the **1** key to display the “Basic Program” screen which provides nine (9) options as shown below:

```

0=CLR  1=AUTO  2=POINT  3=PASSWD  4=MESSAGE
5=ZONES 6=SPL FUNCT  7=SYSTEM  8=CHECK PRG

```

Press the number of any one of the nine (9) options as detailed below

**Option 0=CLR** - Clears all existing user programming. For details, refer to How to Clear Memory (0=CLR) on page 16. Note: The user is prompted to double-check that this is what is really wanted.

**Option 1=AUTO** - Add or remove addressable devices to the control panel program. For details, refer to How to Autoprogram the Control Panel (1=AUTO) on page 16.

**Option 2=POINT** - Modify or delete a point. For details, refer to “How to Modify or Delete a Point (2=POINT)” on page 21.

**Option 3=PASSWD** - Change the Program Change or the Alter Status password. For details, refer to “How to Change a Password (3=PASSWORD)” on page 26.

**Option 4=MESSAGE** - Edit the 40-character message that displays on the first line. For details, refer to “How to Create a System Message (4=MESSAGE)” on page 27.

**Option 5=ZONES** - Edit the 19-character custom zone label for zones 01-99. For details, refer to “How to Create a Custom Zone Label (5=ZONE)” on page 28.

**Option 6=SPL FUNCT** - Program Releasing Zones and Special Zones. For details, refer to “How to Program Special Zones (6=SPL FUNCT)” on page 29.

**Option 7=SYSTEM** - Program Global System Functions. For details, refer to “How to Change Global System Functions (7=SYSTEM)” on page 32.

**Option 8=CHECK PRG** - Check the program for errors. For details, refer to “How to Check the Program for Errors (8=CHECK PRG)” on page 41.

### How to Clear Memory (0=CLR)



Program Change  
Password

The Clear option removes all programming information from control panel memory. If installing the control panel for the first time, use option 0 to clear control panel memory. To do so, follow these steps:

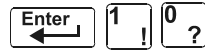

1. From the “Basic Program” screen, press the **0** (zero) key to display the Clear Program screen. The control panel prompts for verification as shown below:

PRESS ENTER TO CLEAR ENTIRE PROGRAM  
OR ESCAPE TO ABORT

2. Press the ENTER key to clear control panel memory or press the ESC key to exit the screen without clearing.

### How to Autoprogram the Control Panel (1=AUTO)

#### Purpose

The Autoprogram option identifies all addressable devices connected to the control panel. Devices include addressable detectors and modules connected to SLC 1 or SLC 2, Panel Circuits connected to J5 and J6, and NACs. You can use the Autoprogram option to create a new program and add or remove devices. A summary of the Autoprogram functions, when to use the functions, and where to find information on using the functions is found below:

Autoprogram Function	Control Panel Configuration	Refer to...
Create a new program for the control panel	A new control panel or a control panel with no existing program in memory.	“Create a New Program for the Control Panel” on page 17
Add one or more SLC-connected detectors and modules to an existing program	A program exists in memory and you want to add a detector or module to the existing program—without modifying information for existing detectors and modules.	“How to Add a Device to the Program” on page 18
Remove one or more SLC-connected detectors and modules from an existing program	A program exists in memory and you want to remove an installed detector or module from the existing program—without modifying information for existing detectors and modules.	“How to Remove a Device from the Program” on page 18
View system defaults	A program exists in memory and you want to view system settings assigned during Autoprogram, such as custom labels, passwords, and so on.	“How to Change Autoprogram Default Values” on page 20



### Create a New Program for the Control Panel



Program Change  
Password

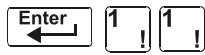

This section covers how to use the Autoprogram option to create a new program for the control panel. The control panel will identify all addressable detectors and modules connected to the SLC.

To create a new program for the control panel, follow these steps:

1. Use the Clear option to clear program information from memory. For instructions on clearing memory, refer to “How to Clear Memory (0=CLR)” on page 16.
2. From the “Basic Program” screen, press the **1** key to start Autoprogram. While the control panel scans the system to identify all SLC devices, Panel Circuits and NACs, it displays the following screen:

```
AUTOPROGRAM      PLEASE WAIT
```

When the autoprogram is finished identifying SLC devices, Panel Circuits and NACs, it displays a summary screen that gives a count of all the devices it has located. Refer to the following screen for an example of this display.

```
L1:010Dets, 159Mods L2:159Dets, 159Mods
Panel Outputs: 64   Bells: 04
```

3. Press ENTER. All devices are automatically accepted during initial autoprogramming. The following screen displays briefly, followed by the SYSTEM NORMAL screen.

```
ACCEPT ALL DEVICES   Please Wait!!!
```

To edit the autoprogramming default values for a point, refer to “How to Modify or Delete a Point (2=POINT)” on page 21.

To edit the autoprogram default values assigned to all modules and detectors during autoprogramming, refer to “How to Change Autoprogram Default Values” on page 20.

### How to Add a Device to the Program

You can also use the Autoprogram option to add addressable devices to the control panel program.

**Note:** When using the Autoprogram option with an existing program, the control panel does not change program information for installed and programmed devices.

The following steps describe how to add a new detector at SLC address 1D147 with 10 detectors in the existing program:

1. Physically install the addressable detector to SLC 1 at address 147 (for instructions, refer to the *NFS-640 Installation Manual* and the installation document that comes with the detector).
2. From the “Basic Program” screen, press the **1** key to start Autoprogram. The Autoprogram Prompt screen appears in the LCD display as the control panel identifies addressable devices. When finished identifying addressable devices, the control panel displays information for the new detector at SLC address 1D147 on the LCD display as shown below:

```

PROGRAM SMOKE (PHOTO) DETECTOR ADDR 1D147
          03 _ _ _ _ ABPB** 1D147
    
```

3. Press the ENTER key to add detector 147 to the program with the default program information. If you want to change the default information, use the programming keys to do so, then press the ENTER key to add detector 147 to the program. The Autoprogram Summary screen appears. You can verify addition of the detector to the program by noting the new count of detectors as shown below:

Note that the number of detectors increases (in this example from 10 to 11) to show the addition of the detector to SLC 1.

```

L1:011Dets, 159Mods L2:159Dets, 159Mods
Panel Outputs: 64 Bells: 04
    
```

4. Press the ENTER key, then press the ESC key to save the program in memory and return to the “Basic Program” screen).

### How to Remove a Device from the Program

You can also use the Autoprogram option to remove addressable detectors and modules from the control panel program.

**Note:** When using the Autoprogram option with an existing program, the control panel does not change program information for installed and programmed devices.

The following steps describe how to delete a detector at SLC address 1D133 with 11 detectors connected to SLC 1 in the existing program:

1. Disconnect and remove the detector from SLC 1 at address 1D133.
2. From the “Basic Program” screen, press the **1** key to start Autoprogram. The Autoprogram Prompt screen displays while the control panel identifies addressable devices.
3. When finished identifying addressable devices, the control panel displays a screen, indicating a missing detector at SLC address 1D133 as shown below:

```

Type Code—
PROGRAM SMOKE (ION) DETECTOR ADDR 1D133
DEVICE NOT ANSWERING DELETE FR MEM?1D133
          SLC loop number—
          D (detector) or M (module)—
          Three-digit address (001-159)—
    
```

4. Press the ENTER key to delete detector 1D133 from the program. The Autoprogram Summary screen appears. You can verify removal of the detector from the

program by noting the new count of detectors as shown below:

Note that the number of detectors decreases (from 11 to 10) to show the removal of the detector from SLC 1.

```
L1:010Dets, 159Mods L2:159Dets, 159Mods  
Panel Outputs: 64 Bells: 04
```

5. Press the ENTER key, then press the ESC key to save the program in memory and return to the “Basic Program” screen.

### How to Change Autoprogram Default Values

To assign system default values from the basic program screen, Press **0** (clear), then press **1** (autoprogram). Refer to the chart below for default values and how to modify them.

Function	Default Values	To Alter, refer to
Software Zones 01-99	default custom label "Zone xx" where xx is the number of the zone <b>Note:</b> Zone 00 is reserved for a general alarm.	"How to Create a Custom Zone Label (5=ZONE)" on page 28
F0	PRG PRESIGNAL FUNCT PRESIGNAL DELAY DELAY=180 PAS=NO F00	"F0 (Presignal/PAS)" on page 30
Releasing Zones R0-R9	PRG RELEASE FUNCT RELEASE CONTROL DELAY=00 ABORT=ULI CROSS=N SOK=0000	"R0-R9 (Releasing Functions)" on page 30 and "How to Program a Releasing Zone" on page 54
F5 and F6	PRG TIME FUNCTION TIME CONTROL ON=*** OFF=*** DAYS=*****	"F5-F6 (Time Control Functions)" on page 30
F7	PRG HOLIDAY FUNCTION **/** **/** **/** **/** **/** **/** **/** **/** **/**	"F7 (Holiday)" on page 31
F8	PRG CODING FUNCTION CODE TYPE MARCH TIME F08	"F8 (Coding Function)" on page 31
F9	PRE-ALARM FUNCT ALERT F09	"F9 (Pre-Alarm)" on page 31
System Parameters	SIL INH=0000 AUTO=0077 0 VERIFY=30 USA TIME TERM=N AC_DLY=Y LocT BLINK=01 ST=4 ACS=N	"How to Change Global System Functions (7=SYSTEM)" on page 32
Passwords	Default programming passwords are: Program Change=00000 Status Change=11111	"How to Change a Password (3=PASSWD)" on page 26
SYSTEM NORMAL message	(YOUR CUSTOM SYSTEM MESSAGE HERE) SYSTEM NORMAL 10:23A 071201 Thu A message, along with the current day, time, and date, that displays on the second line of the LCD display during normal operation.	<b>Note:</b> The second line, "SYSTEM NORMAL", is a standard system message that you cannot change.
System Message	(YOUR CUSTOM SYSTEM MESSAGE HERE) SYSTEM NORMAL 10:23A 071201 Thu The first line of the LCD display contains 40 blank characters for a custom message.	"How to Create a System Message (4=MESSAGE)" on page 27

### How to Modify or Delete a Point (2=POINT)

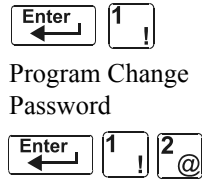

After programming all SLC-connected devices into the system, you can modify or delete points. From the “Basic Program” screen, press the **2** key to display the Point Programming screen:

```
POINT PROG.          1=MODIFY POINT
2=DELETE POINT
```

To modify a point for a detector, module, or NAC/Panel Circuit: press the **1** key to display the “Modify Point” screen.

To delete a point for a detector, module, or NAC/Panel Circuit: press the **2** key to display the “Delete Point” screen.

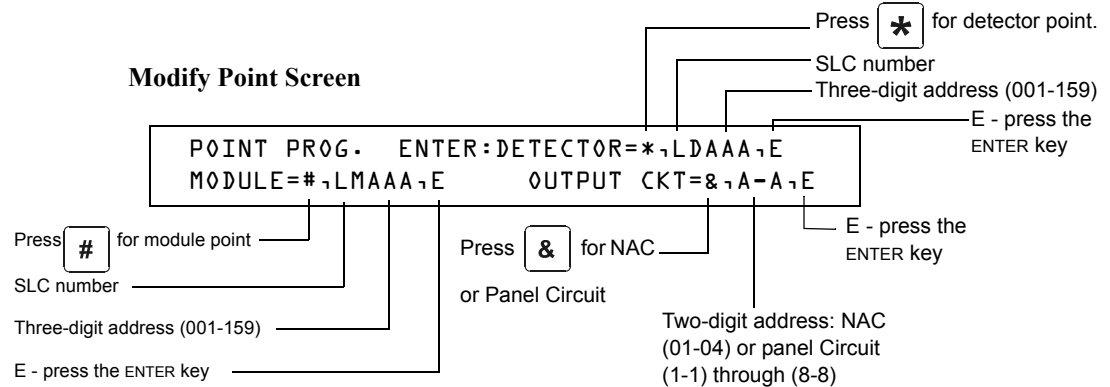

#### Delete Point Screen

```
DELETE POINT.  ENTER:DETECTOR=* ,LDAAA ,E
MODULE=# ,LMAAA ,E      OUTPUT CKT=& ,A-A ,E
```

The Modify Point and Delete Point screens let you edit or delete points for a detector, a monitor or control module, NAC or Panel Circuit. To select a point, follow these steps:

To select	Do the following	Refer to
an addressable detector	Press <b>*</b> Type the SLC number (1 or 2) and detector (D) and address (001-159) Press <b>Enter</b>	“How to Modify an Addressable Detector Point” on page 22
an addressable monitor module	Press <b>#</b> Type the SLC number (1 or 2) and module (M) and address (001-159) Press <b>Enter</b>	“How to Modify an Addressable Monitor Module Point” on page 23
an addressable control module	Press <b>#</b> Type the SLC number (1 or 2) and module (M) and address (001-159) Press <b>Enter</b>	“How to Modify an Addressable Control Module Point” on page 24
a NAC or Panel Circuit	Press <b>&amp;</b> Type the NAC address (01-04) or Panel Circuit address: (1-1) through (8-8) Press <b>Enter</b>	“How to Modify NAC and Panel Circuit Points” on page 25

The next four sections describe how to program the points selected.

### How to Modify an Addressable Detector Point

This section contains a sample detector programming screen, detector default selection, and instructions for modifying a detector point. Autoprogram default values for a detector are shown:

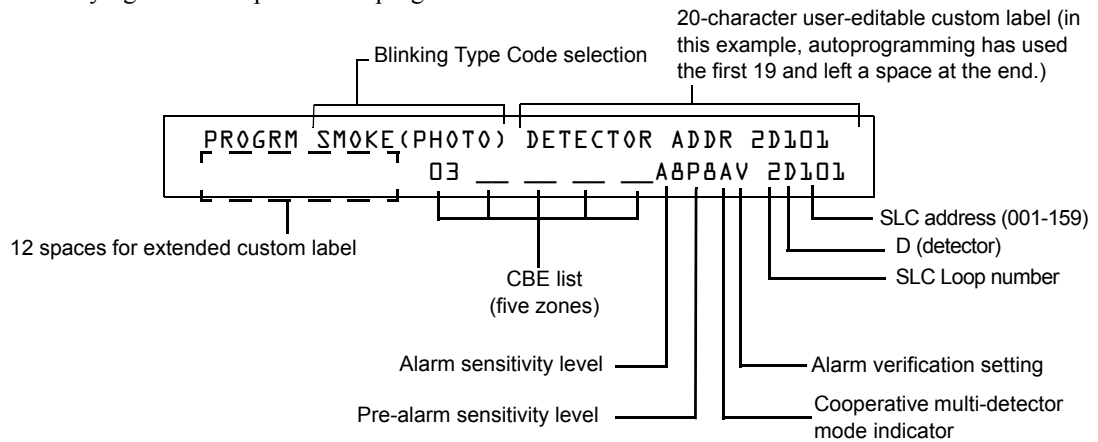

Field	Description	Set as Follows
Type Code	Detector function specification - SMOKE(PHOTO) in example.	Press the NEXT or PREVIOUS Selection keys to scroll through valid detector Type Code selections. See Table 32 on page 104 for lists and descriptions.
Custom Label	20 character custom label.	Change by placing the cursor into the first space of the field using the arrow keys, then typing the descriptor. DETECTOR ADDR 2D101 is the autoprogram default custom label for the detector at address 101 on SLC 2.
Extended Label	12 character custom label extension.	See "Custom Label" above. Note: Spaces must be input by the user, including any space necessary between the custom and extended label fields. An 80-column printout will run the two fields together.
CBE List	Five zones can be listed - one zone, Z03, is shown in the example. Up to 4 more could be added to this detector.	Zones can be changed or added to the CBE list by placing the cursor in the zone field using arrow keys, then typing. Defaults: Zone 01 (Heat detectors) Zone 02 (Ion detectors) Zone 03 (Photo detectors) Zone 04 (Laser detectors) Zone 05 (Multisensor)
Alarm Sensitivity	The alarm sensitivity level, with 9 the least sensitive alarm level and 1 the most sensitive alarm level.	Refer to Table 30 on page 90 for settings. Select by placing the cursor in the field using the arrow keys, then either pressing the NEXT or PREVIOUS keys to make the selection, or typing the value. Defaults: A8 (Photo) A6 (Ion) A6 (Laser ) A5 (Multisensor )
Pre-alarm level	Shows the Pre-Alarm level setting—a number between 0 and 9—as follows: 0 – no Pre-Alarm 1 – self optimizing 2 – most sensitive Pre-Alarm level 9 – least sensitive Pre-Alarm level	Refer to Table 30 on page 90 for settings. Select by placing the cursor in the field using the arrow keys, then either pressing the NEXT or PREVIOUS keys to make the selection, or typing the value. Defaults: P8 (Photo) P6 (Ion) P6 (Laser) P5 (Multisensor)
Cooperative Multi-detector mode	Indicates the cooperative multi-detector mode (A in the example).	Select by placing the cursor in the field using the arrow keys, then either pressing the NEXT or PREVIOUS keys to make the selection, or typing the value. * = OFF (Default) A combines the detector's alarm decision with the next address above B combines the detector's alarm decision with the next address below C combines the detector's alarm decision with the next address above and the next address below
Alarm verification	Indicates the alarm verification setting (V in the example).	Indicates Alarm Verification (V=on, *=off). Select by placing the cursor in the field using the arrow keys, then pressing the NEXT or PREVIOUS keys to make the selection. Refer to "How to Interpret a Detector Status Display or Maintenance Report" on page 93 for more information on the alarm verification feature.

**Table 4 Detector Program Values**

**How to Modify an Addressable Monitor Module Point**

When you select a point address, the control panel returns a screen that displays information about the point. Below is an example of information for a monitor module (2M101) in the LCD display:

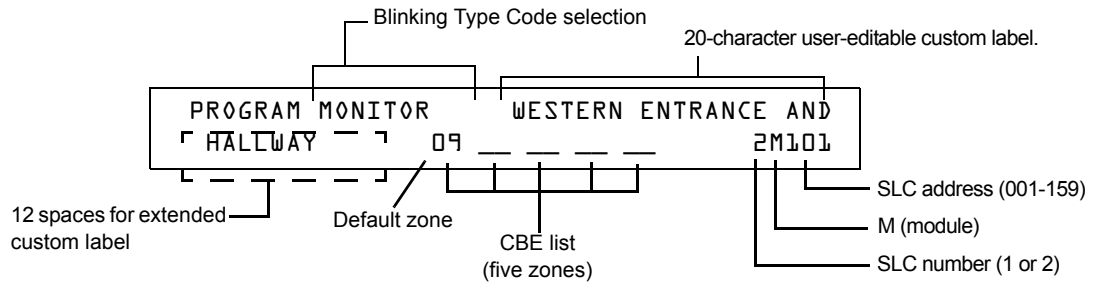

Field	Description	Set as Follows
Type Code	Monitor Module function specification - MONITOR in example.	Press the NEXT or PREVIOUS Selection keys to scroll through valid monitor module Type Code selections. Lists and descriptions are in See Table 33 on page 105.
Custom Label	20 character custom label.	Change by placing the cursor into the first space of the field using the arrow keys, then typing the descriptor. Note: Spaces must be input by the user, including any space necessary between the custom and extended label fields. An 80-column printout will run the two fields together.
Extended Label	12 character custom label extension.	See "Custom Label" above.
CBE List	Five zones can be listed - one zone, Z09, is shown in the example. Up to 4 more could be added to this module.	Zones can be changed or added to the CBE list by placing the cursor in the zone field using arrow keys, then typing. See Table 6 on page 23 for defaults.

**Table 5 Modifying Monitor Module Programming Selections**

**Modifying Control Module Programming Selections**

When finished modifying a point, press the ENTER key; then press the NEXT or PREVIOUS key to select another point.

**Monitor Module Default Zone Assignments**

Listing of the monitor module address range and the default zone assignment for each range:

Monitor Module Address	Zone Default
01 through 19	Z04
20 through 39	Z05
40 through 59	Z06
60 through 79	Z07
80 through 99	Z08
100 through 119	Z09
120 through 139	Z10
140 through 159	Z11

**Table 6 Monitor Module Default Zones**

### How to Modify an Addressable Control Module Point

When you select a point address for modification, the control panel returns a screen that displays information about the point. For example, the illustration below shows sample information for a control module (2M101) in the LCD display.

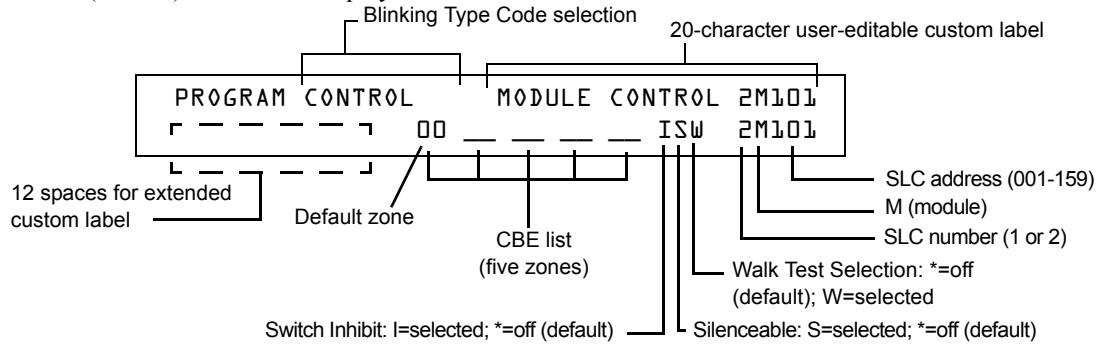

**Note:** On a control module, the default zone is always set to Zone 00 (general alarm).

To modify a point, follow these steps:

**Note:** A blinking cursor indicates the selected field.

1. From the programming screen, use the arrow keys to move to a field that you want to modify. See below for descriptions and settings.

Field	Description	Set as follows:
Type Code	Specifies the function of the control module	Press the NEXT or PREVIOUS Selection keys to scroll through valid control module Type Code selections (listed in Table 34 on page 106)
Custom Label	20 character custom label.	Change by placing the cursor into the first space of the field using the arrow keys, then typing the descriptor. Note: Spaces must be input by the user, including any space necessary between the custom and extended label fields. An 80-column printout will run the two fields together.
Extended Label	12 character custom label extension.	See "Custom Label" above.
CBE list	Up to five software zones can be entered to define the output responses of the control module based on various initiating conditions (events)	Type the number of up to five zones, including E0-E9, F0-F9, L0-L9, R0-R9, and zones 00-99. The first zone default is Z00 (general alarm).
Switch Inhibit	Specifies if an operator can manually activate an output	Type one of the following entries. I = Switch Inhibit enabled * = no switch inhibit (default for all but releasing circuits)
Silenceable	Specifies if an operator can manually silence an activated output	Type one of the following entries. * = output nonsilenceable F = silenceable, resound by fire alarm U = silenceable, resound by supervisory alarm B = silenceable, resound by security alarm T = silenceable, resound by trouble O = silenceable, does not resound Note: If the "Strobe" Type ID is used with System Sensor Strobe synchronization, F, U, B, T, or O will silence the entire circuit, "*" will silence the horn portion only.
Walk Test	Specifies if outputs sound during Walk Test	Type one of the following entries. W = devices sound (Basic Walk Test) * = devices do not sound (Silent Walk Test) (default)

**Table 7 Modifying Control Module Programming Selections**

2. When finished modifying a point, press the ENTER key; then press the NEXT or PREVIOUS key to select another point.



### How to Modify NAC and Panel Circuit Points

Modifying NAC (four NACs on the NFS-640) and Panel Circuits (connected through J5 or J6) is like modifying control modules—except for the Type Code and device address.

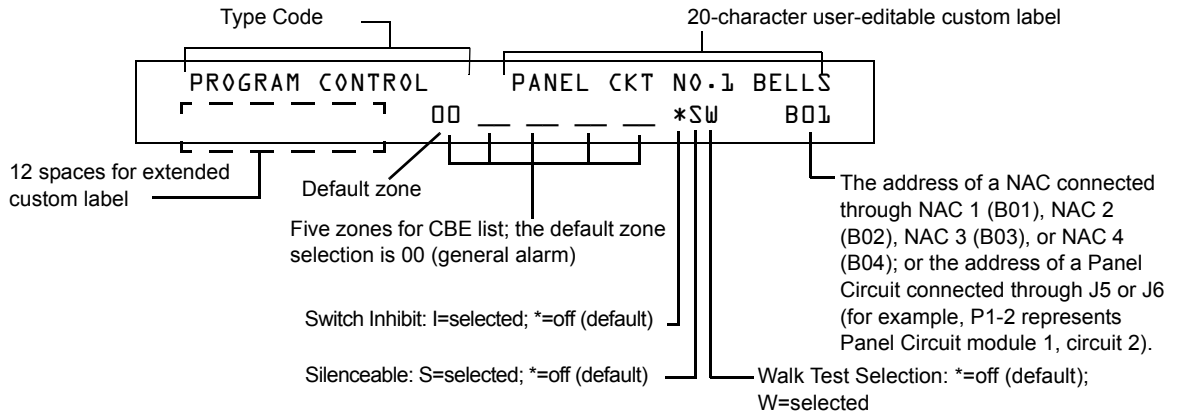

To modify a point, follow these steps:

**Note:** A blinking cursor indicates the selected field.



1. From the programming screen, use the arrow keys to move to a field that you want to modify and refer to information below for descriptions and settings.

Field	Description	Set as follows:
Type Code	Specifies the function of the NAC or Panel Circuit	Press the NEXT or PREVIOUS Selection keys to scroll through the NAC or Panel Circuit Type Code selections (listed in Table 35 on page 107)
Custom Label	20 character custom label.	Change by placing the cursor into the first space of the field using the arrow keys, then typing the descriptor. Note: Spaces must be input by the user, including any space necessary between the custom and extended label fields. An 80-column printout will run the two fields together.
Extended Label	12 character custom label extension.	See "Custom Label" above.
CBE zones	Specifies up to five software zones to define the output responses of the NAC or Panel Circuit based on various initiating conditions (events)	Type the numbers of up to five zones, including E0-E9, F0-F9, L0-L9, R0-R9, and zones 00-99. The first zone default is 00 (general alarm)
Switch Inhibit	Specifies if an operator can manually activate an output	Type in one of the following values. I = Switch Inhibit enabled * = Switch Inhibit disabled (default for all but releasing circuits)
Silenceable	Specifies if an operator can manually silence an activated output	Type in one of the following values. * = output nonsilenceable F = silenceable, resound by fire alarm U = silenceable, resound by supervisory alarm B = silenceable, resound by security alarm T = silenceable, resound by trouble O = silenceable, does not resound
Walk Test	Specifies if outputs sound during Walk Test	Type in one of the following values. W = devices sound (Basic Walk Test) - default * = devices do not sound (Silent Walk Test)

**Table 8 Modifying a NAC/Panel Circuit Programming Selections**

2. When finished modifying a point, press the ENTER key; then press the NEXT or PREVIOUS key to select another point.

### How to Change a Password (3=PASSWD)

  
 Program Change  
 Password

Password Change lets you select a custom Program Change (high level) or Status Change (low level) password. From the “Basic Program” screen, press the **3** key to display the “Change Password” screen.









```

CHANGE PASSWORD      * 1 NNNNN 1 E=PROGRAM
# 1 NNNNN 1 E=STATUS  
    
```

Entry area for new password

To change a password, follow the instructions below:

To	Press	Then
Change the Program Change password		Enter the new Program Change password. Use five digits, no characters.
Change the Status Change password		Enter the new Status Change password. Use five digits, no characters.
Save the password		The Verify Password screen appears. Press ENTER to verify.
Leave the Change Password screen without changing a password		The Basic Program screen appears.

### A Forgotten Password?

If a password is entered incorrectly, the panel will respond by displaying an INCORRECT PASSWORD message and a code. The programmer may hit escape and reenter the password correctly. However, if the password has been forgotten, record the code and contact Notifier. After proper authentication, the original password can be determined by deciphering the code. An example of an INCORRECT PASSWORD display is given below:

```

INCORRECT PASSWORD
PROGRAM: 9066-21F5-7D78-5FA4-6163
    
```

Code

### How to Create a System Message (4=MESSAGE)



Program Change  
Password

The Message option lets you create a 40-character custom System Message that displays on the first line of the “SYSTEM NORMAL” screen as shown below:

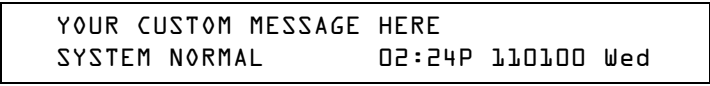

From the “Basic Program” screen, press the 4 key to display the “System Message Change” screen:

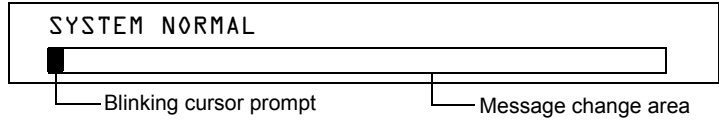

To create the system message, follow these guidelines:

- Enter one character at a time, indicated by the blinking cursor on the second line of the display.
- Enter up to 40 characters maximum.

Instructions for entering characters in the Message Change screen:

To	Do this
Change a blinking character	Enter a character from the keypad
Move to the next character	Press
Enter lower case characters	Press  , then press the character of your choice.
Enter additional characters ( ! @ = , % : \ .   ? )	Press  , then press a number key as follows:  For example, press  , then press the 3 (  ) key to enter a “=” character.
Save the new message	Press

### How to Create a Custom Zone Label (5=ZONE)

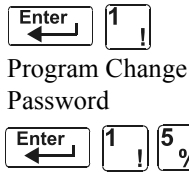

The Zone option lets you change the custom label assigned to zones 1-99. From the “Basic Program” screen, press the 5 key to display the “Zone Change” screen as shown below:

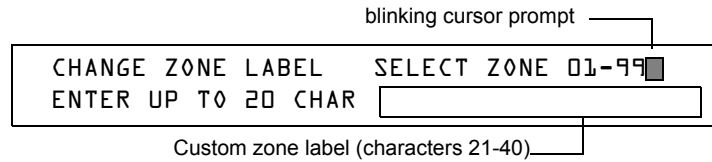

The zone number displays in the first line, characters 39 and 40. When changing a zone label, follow these guidelines.

- For single-digit numbers, enter a leading zero before the digit.
- Enter an alphanumeric zone label into line 2, characters 21–40. The program forces a blank for the first character, which inserts a space between the device and zone labels for a printout.

To change a custom label for a zone, follow these instructions:

To	Do this
Change a zone label	Enter a new zone label from the keypad.
Save the zone label in memory	Press  . The program stores the zone label in memory and displays the Zone Change screen with all fields blank.
Leave the Zone Change screen without changing a zone label	Press  . The display returns to the Program Change screen.

### How to Program Special Zones (6=SPL FUNCT)



Program Change  
Password

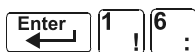

The Special Zone Change option lets you change the program for Special Zones F0-F9 or Releasing Zones R0-R9. From the “Basic Program” screen, press the 6 key to display the “Special Function Change” screen as shown below:

SPECIAL FUNCTION: F0=PRESIG R0-R9=REL  
F5-F6=TIME F7=HOL F8=CODE F9=PRE-ALARM

### What are Special Zones?

Descriptions for each Special Zone that appears in the “Special Function Change” screen are detailed below:

**Note:** Special Zones F0-F9 appear in the CBE list of device as ZF0-ZF9. For example, if you list F0 for a detector, one of the five zones in the CBE list of the detector will display as ZF0.

Special Zone	Lets you
F0=PRESIG	Select a Presignal Delay Timer and select PAS (Positive Alarm Sequence)
F5-F6=TIME	Specify Time Control functions such as the start time, stop time, or days of the week
F7=HOL	Specify up to nine holiday dates. An F7-programmed device activates on the specified holiday dates
F8=CODE	Specify one of seven coding function selections: March Time, Temporal, California, Two-Stage, Canadian Two-Stage (3 minute or 5 minute), or System Sensor Strobes. F8 only takes effect if you program one or more NACs to F8
F9=PRE-ALARM	Select a Pre-Alarm level: Alert or Action
R0-R9=REL	Program up to ten Releasing Zones, each with a selection for a Delay Timer, an Abort Switch, a Cross Zone selection, or a Soak Timer

**Table 9 Summary of Special Zones**

The control panel also provides four Special Zones, F1-F4, which are outputs that do not appear on the Special Function Change screen. You can program Special Zones F1 to F4 into the CBE of an output device. Descriptions of F1, F2, F3, and F4 are detailed below:

**Note:** To view the status of Special Functions F1-F4, use the Read Status function (refer to the *NFS-640 Operations Manual*).

Special Function	Specifies
F1 (Trouble less AC)	An output programmed to turn on/off if a system trouble—other than an AC power loss—occurs
F2 (AC Trouble)	An output programmed to turn on/off if an AC power loss or a brownout condition occurs
F3 (Security)	An output programmed to turn on/off if a Security input activates
F4 (Supervisory)	An output programmed to turn on/off if a Supervisory input activates

**Table 10 Special Output Functions F1-F4**

**How to Select Special Zones**

Select Special Zones by entering the Special Zone letter and number (for example, F0, R0, and so on) from the Special Function Change screen. The following sections show sample screens that display when you select a Special Zone.

**F0 (Presignal/PAS)** The Presignal screen provides fields for changing the delay time or PAS. For details on Presignal selections, refer to “Presignal and Positive Alarm Sequence (PAS)” on page 80. From the Special Function Change screen, press the **F** key, then press the **0** key to display the Presignal Function screen.

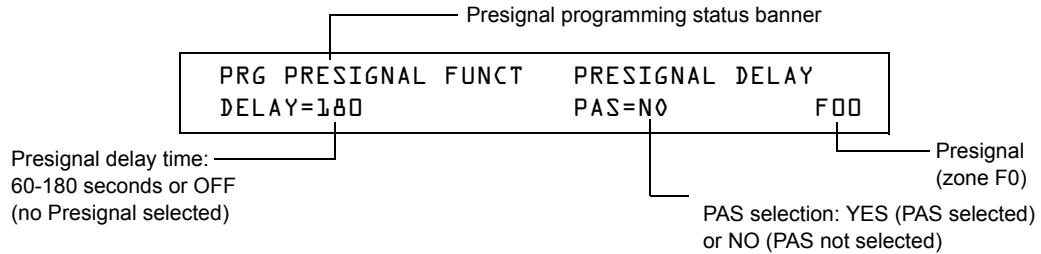

**R0-R9 (Releasing Functions)** The Releasing Function screen provides fields for changing releasing functions: Delay Timer, Abort Switch, Cross Zone, and Soak Timer. For details on releasing applications, refer to “Appendix A: Releasing Applications” on page 53. From the Special Function Change screen, select a function (R0-R9) to display the Releasing Function screen:

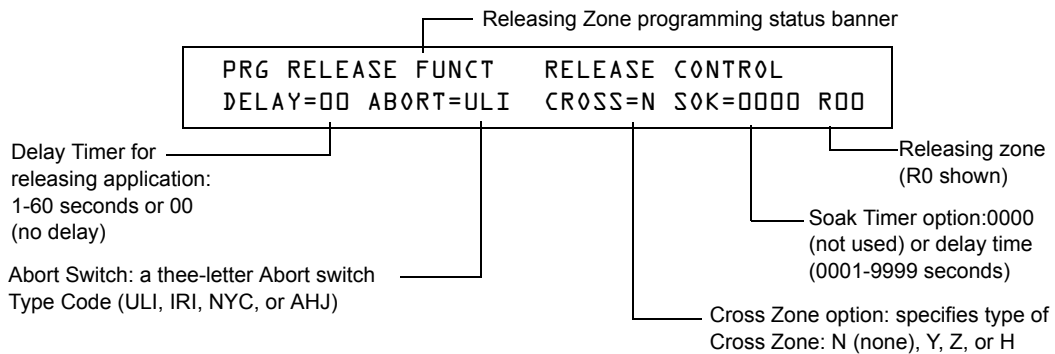

**F5-F6 (Time Control Functions)** The Time Control screen provides fields for changing the start time, stop time, or days of the week. For details on time selections, refer to “Time Control Zones” on page 82. From the Special Function Change screen, select F5 or F6 to display the Time Control screen:

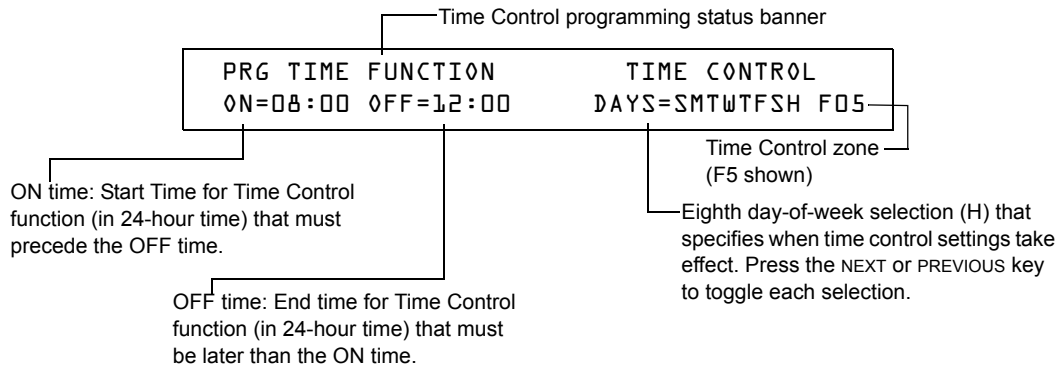

*Continued on the next page...*

**F7 (Holiday)** The Holiday screen provides fields for specifying up to nine holiday dates. For details on holiday selections, refer to “Time Control Zones” on page 82. From the Special Function Change screen, press **F7** to display the Holiday screen:

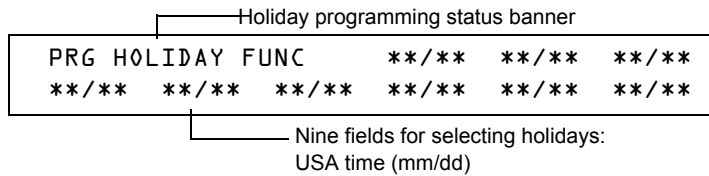

**F8 (Coding Function)** The Coding Function screen provides fields for specifying one of seven coding functions: March Time, Two-stage, California, Temporal, Canadian Two-Stage (3 minutes), Canadian Two-Stage (5 minutes), and System Sensor Strobe. For details on selecting coding functions, refer to “Coding Functions for NACS and Panel Circuits” on page 82. From the Special Function Change screen, press **F8** to display the Coding Function screen:

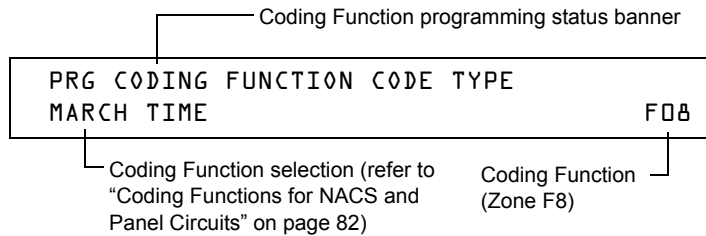

**F9 (Pre-Alarm)** The Pre-Alarm screen provides fields for programming the Alert or Action Pre-Alarm functions. For details on Pre-Alarm selections, refer to “Pre-Alarm” on page 88. From the Special Function Change screen, press **F9** to display the Pre-Alarm screen:

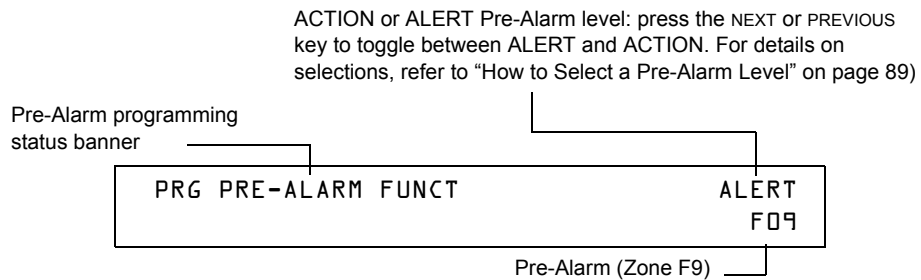

### How to Change Global System Functions (7=SYSTEM)

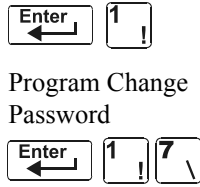

The System option lets you select settings for global system functions that apply to all programmed devices and zones. For instance, selecting an Alarm Verification Timer for 30 seconds means that all initiating devices selected for Alarm Verification use a 30-second timer. From the “Basic Program” screen, press the 7 key to display the “System Function” screen as shown below:

```
SIL INH=000 AUTO=000 VERIFY=30 USA TIME
TERM=N AC_DLY=Y LocT BLINK=01 ST=4 ACS=N
```

### Global System Functions

Settings for global system functions:

System Function	Setting	Default
SIL INH (Silence Inhibit Timer)	0 to 300 seconds	000
AUTO (Auto Silence Timer) - After the time delay expires, functions like pressing the SIGNAL SILENCE key, silencing active outputs programmed as silenceable.	000 (none); 600 to 900 seconds	000
VERIFY (Alarm Verification Timer)	0 to 60 seconds*	60
USA TIME	USA time (mm/dd/yy) or EUR time (dd/mm/yy) Press the NEXT or PREVIOUS key to change. Note that (European) time changes to 24-hour time format and date format.	USA
TERM - Allows supervision for devices connected to TB12, i.e., LCD-80.	N = no supervision Y = supervision enabled	N
AC_DLY	AC delay – delays loss of AC reporting for 8 hours. Y=AC delay; N=no AC delay	Y
LocX - One of three operating modes of PC or terminal connected to the control panel through TB15 on the CPU-640.  <b>Note:</b> For a complete list of functions, refer to the <i>NFS-640 Operations Manual</i> .	LocT -(terminal connected to control panel and located in same room).  LocM -(same as LocT but requires password).  RemT -(terminal connected through a modem for Read Status only).	LocT
BLINK - Addressable SLC device LED blink.	Select from 00 to 16. (00 = no blink, 01 = blink every poll, 02 = blink every 2nd poll, 03 = blink every 3rd poll up to 16 = blink every 16th poll). <b>Note:</b> This setting affects FlashScan modules only.	01
ST - The NFPA wiring style used for the SLC.	6=Style 6 SLC wiring 4=Style 4 SLC wiring	4
ACS - Use ACS Selection Groups (Refer to “Annunciator Options” on page 33).	N or Y	N
*This value can not exceed 30 seconds for ULC installations.		

**Table 11 Settings for Global Systems Functions**



### Annunciator Options

Use Annunciator Selection screens to select information that will display on the ACS annunciators. (Table 12 on page 34 contains the ACS display selections.) Setting ACS=Y from the “System Function” screen displays the Annunciator Selection 1 screen, address A1 - A11. Press enter to display Annunciator Selection 2 screen, address A12 - A19:

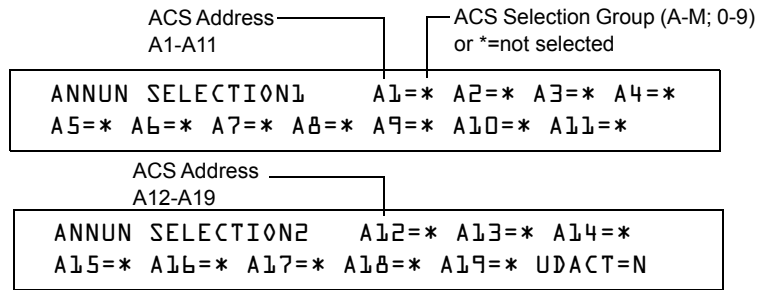

If UDACT=Y: Addresses A20-A32 are available with UDACTs having software release #UDACT02.1 or higher to send control panel status to aUDACT.  
If UDACT=N: The control panel displays the Annunciator Selection 3 & 4 screen addresses A20-A32.

Enter “N” (ACS Selection Group N) for a TM-4 module used for remote station communication.

Enter “O” (ACS Selection Group O) for a TM-4 used as a municipal box trip. This will provide a “Master Box” trouble message at the panel.

Refer to page 40 for further information on Group N and Group O.

### ACS Selection Group Example

An example of a screen listing ACS Selection Groups (H, I and M):

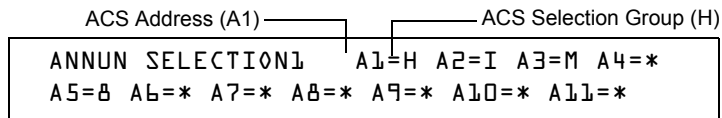

Annunciator selections for addresses A1, A2 and A3 (addresses A4-A11 not selected).

- Annunciators set to Address 1 display the status of detectors 1-64 (Group H) on SLC 1
- Annunciators set to Address 2 display the status of detectors 1-64 (Group I) on SLC 2
- Annunciators set to Address 3 display the status of the Panel Circuit modules (Group M)

### Annunciation Points

The control panel's annunciation points are divided into 23 ACS selection groups of 64 points each. The table below contains a list of these groups, what an annunciator displays when a group is selected, and where to locate a definition of the 64 points within the group.

ACS Selection Group	Annunciator Display	Refer to
A	8 System points & Zones 1 - 56	Table 13 on page 35
B	Zones 57 - 99, 9 F Zones, 8 R Zones, 4 NACs	Table 14 on page 35
C	Loop 1, Modules 1 - 64	Table 15 on page 36
D	Loop 2, Modules 1 - 64	Table 16 on page 36
E	Loop 1, Modules 65 - 128	Table 17 on page 36
F	Loop 2, Modules 65 - 128	Table 18 on page 36
G	Loop 1, Modules 129 - 159 (1 unused point) Loop 2, Modules 129 - 159 (1 unused point)	Table 19 on page 37
H	Loop 1, Detectors 1 - 64	Table 20 on page 37
I	Loop 2, Detectors 1 - 64	Table 21 on page 37
J	Loop 1, Detectors 65 - 128	Table 22 on page 38
K	Loop 2, Detectors 65 - 128	Table 23 on page 38
L	Loop 1, Detectors 129 - 159 (1 unused point) Loop 2, Detectors 129 - 159 (1 unused point)	Table 24 on page 38
M	Panel Circuits 1.1 to 8.8 (64)	Table 25 on page 39
N	8 System Points & Zones 1-56	"ACS Selection Group N" on page 40
O	8 System Points & Zones 1-56	"ACS Selection Group O" on page 40
1	Programmable Annunciator #1	See Note
2	Programmable Annunciator #2	See Note
3	Programmable Annunciator #3	See Note
4	Programmable Annunciator #4	See Note
5	Programmable Annunciator #5	See Note
6	Programmable Annunciator #6	See Note
7	Programmable Annunciator #7	See Note
8	Programmable Annunciator #8	See Note
9	Programmable Annunciator #9	See Note
0	Programmable Annunciator #10	See Note

**Table 12 ACS Selection Groups**

**Note:** Refer to the VeriFire™ Tools programming utility for programming these annunciators.

**ACS Selection Group A:**

Point	Type	Red LED	Yellow LED	Switch Function*
1	Input	System Alarm	System Trouble	Acknowledge
2	Output	Not Used	Signal Silenced	Alarm Silence
3	Output	Not Used	Program Mode	System Reset
4	Output	Not Used	Supervisory	Drill
5	Output	NAC #1 Active	NAC Trouble	Control NAC #1
6	Input	Not Used	P/A Maint. Alert	Not Used
7	Input	Not Used	Low Battery	Not Used
8	Input	Not Used	AC Fail	Not Used
9	Input	Zone 1 Active	Zone 1 Trouble	Not Used
10	Input	Zone 2 Active	Zone 2 Trouble	Not Used
11	Input	Zone 3 Active	Zone 3 Trouble	Not Used
to		to (see note)	to (see note)	
64	Input	Zone 56 Active	Zone 56 Trouble	Not Used
* Pressing the switch button when the Switch Function is "Not Used" will cause the associated LED to stop blinking. This is a local acknowledgement at the annunciator only; no message is sent to the panel.				

**Table 13 ACS Group A**

**Note:** Point number to Zone number relationship is sequential. To determine Point to Zone relationship subtract **8** from Point number to arrive at Zone number.

**ACS Selection Group B:**

Point	Type	Red LED	Yellow LED	Switch Function*
1	Input	Zone 57 Active	Zone 57 Trouble	Not Used
2	Input	Zone 58 Active	Zone 58 Trouble	Not Used
3	Input	Zone 59 Active	Zone 59 Trouble	Not Used
to		to (see note 1)	to (see note 1)	
43	Input	Zone 99 Active	Zone 99 Trouble	Not Used
44	Output	Zone F1 Active	Zone F1 Trouble	Not Used
45	Output	Zone F2 Active	Zone F2 Trouble	Not Used
to		to (see note 2)	to (see note 2)	
52	Output	Zone F9 Active	Zone F9 Trouble	Not Used
53	Release Ckt #0	Zone R0 Active	Zone R0 Trouble	Not Used
54	Release Ckt #1	Zone R1 Active	Zone R1 Trouble	Not Used
to	to	to (see note 2)	to (see note 2)	
60	Release Ckt #7	Zone R7 Active	Zone R7 Trouble	Not Used
61	NAC Output	NAC B01 Active	NAC B01 Trouble	Controls NAC B01
62	NAC Output	NAC B02 Active	NAC B02 Trouble	Controls NAC B02
63	NAC Output	NAC B03 Active	NAC B03 Trouble	Controls NAC B03
64	NAC Output	NAC B04 Active	NAC B04 Trouble	Controls NAC B04
* Pressing the switch button when the Switch Function is "Not Used" will cause the associated LED to stop blinking. This is a local acknowledgement at the annunciator only; no message is sent to the panel.				

**Table 14 ACS Group B**

**Note:** 1- Point number to Zone number relationship is sequential. To determine Point to Zone relationship add **56** to Point number to arrive at Zone number.

**Note:** 2- Point number to Zone number relationship is sequential; therefore, point 48 is zone F5 and point 57 is zone R4

**ACS Selection Group C (SLC #1, Modules 1-64):**

Point	Type	Red LED	Yellow LED	Switch Function
1	Input or Output	Module 001 Active	Module 001 Trouble	Controls Output Module
2	Input or Output	Module 002 Active	Module 002 Trouble	Controls Output Module
3	Input or Output	Module 003 Active	Module 003 Trouble	Controls Output Module
to		to (see note)	to (see note)	
64	Input or Output	Module 064 Active	Module 064 Trouble	Controls Output Module

**Table 15 ACS Group C**

**Note:** Point number to Module number relationship is sequential; therefore, point 48 is Module 048.

**ACS Selection Group D (SLC #2, Modules 1-64):**

Point	Type	Red LED	Yellow LED	Switch Function
1	Input or Output	Module 001 Active	Module 001 Trouble	Controls Output Module
2	Input or Output	Module 002 Active	Module 002 Trouble	Controls Output Module
3	Input or Output	Module 003 Active	Module 003 Trouble	Controls Output Module
to		to (see note)	to (see note)	
64	Input or Output	Module 064 Active	Module 064 Trouble	Controls Output Module

**Table 16 ACS Group D**

**Note:** Point number to Module number relationship is sequential; therefore, point 48 is Module 048.

**ACS Selection Group E (SLC #1, Modules 65-128):**

Point	Type	Red LED	Yellow LED	Switch Function
1	Input or Output	Module 065 Active	Module 065 Trouble	Controls Output Module
2	Input or Output	Module 066 Active	Module 066 Trouble	Controls Output Module
3	Input or Output	Module 067 Active	Module 067 Trouble	Controls Output Module
to		to (see note)	to (see note)	
64	Input or Output	Module 128 Active	Module 128 Trouble	Controls Output Module

**Table 17 ACS Group E**

**Note:** Point number to Module number relationship is sequential. To determine Point to Module relationship add **64** to Point number to arrive at Module number.

**ACS Selection Group F (SLC #2, Modules 65-128):**

Point	Type	Red LED	Yellow LED	Switch Function
1	Input or Output	Module 065 Active	Module 065 Trouble	Controls Output Module
2	Input or Output	Module 066 Active	Module 066 Trouble	Controls Output Module
3	Input or Output	Module 067 Active	Module 067 Trouble	Controls Output Module
to		to (see note)	to (see note)	
64	Input or Output	Module 128 Active	Module 128 Trouble	Controls Output Module

**Table 18 ACS Group F**

**Note:** Point number to Module number relationship is sequential. To determine Point to Module relationship add **64** to Point number to arrive at Module number.

**ACS Selection Group G (SLC #1 and #2, Modules 129-159):**

Point	Type	Red LED	Yellow LED	Switch Function
1	Output	SLC 1, Module 129 Active	SLC 1, Module 129 Trouble	Controls SLC 1, Module 129
2	Output	SLC 1, Module 130 Active	SLC 1, Module 130 Trouble	Controls SLC 1, Module 130
3	Output	SLC 1, Module 131 Active	SLC 1, Module 131 Trouble	Controls SLC 1, Module 131
to		to (see note 1)	to (see note 1)	
31	Output	SLC 1, Module 159 Active	SLC 1, Module 159 Trouble	Controls SLC 1, Module 159
32	Not Used			
33	Output	SLC 2, Module 129 Active	SLC 2, Module 129 Trouble	Controls SLC 2, Module 129
34	Output	SLC 2, Module 130 Active	SLC 2, Module 130 Trouble	Controls SLC 2, Module 130
35	Output	SLC 2, Module 131 Active	SLC 2, Module 131 Trouble	Controls SLC 2, Module 131
		to (see note 2)	to (see note 2)	
63	Output	SLC 2, Module 159 Active	SLC 2, Module 159 Trouble	Controls SLC 2, Module 159
64	Not Used			

**Table 19 ACS Group G**

**Note:** 1- Point number to Module number relationship is sequential. To determine Point to Module relationship add **128** to Point number to arrive at Module number.

**Note:** 2- Point number to Module number relationship is sequential. To determine Point to Module relationship add **96** to Point number to arrive at Module number.

**ACS Selection Group H (SLC #1):**

Point	Type	Red LED	Yellow LED	Switch Function*
1	Input	Detector 001 Alarm	Detector 001 Trouble	Not Used
2	Input	Detector 002 Alarm	Detector 002 Trouble	Not Used
3	Input	Detector 003 Alarm	Detector 003 Trouble	Not Used
to		to (see note)	to (see note)	
64	Input	Detector 064 Alarm	Detector 064 Trouble	Not Used
* Pressing the switch button when the Switch Function is "Not Used" will cause the associated LED to stop blinking. This is a local acknowledgement at the annunciator only; no message is sent to the panel.				

**Table 20 ACS Group H**

**Note:** Point number to Detector number relationship is sequential; therefore, point 48 is Detector 048.

**ACS Selection Group I (SLC #2):**

Point	Type	Red LED	Yellow LED	Switch Function*
1	Input	Detector 001 Alarm	Detector 001 Trouble	Not Used
2	Input	Detector 002 Alarm	Detector 002 Trouble	Not Used
3	Input	Detector 003 Alarm	Detector 003 Trouble	Not Used
to		to (see note)	to (see note)	
64	Input	Detector 064 Alarm	Detector 064 Trouble	Not Used
* Pressing the switch button when the Switch Function is "Not Used" will cause the associated LED to stop blinking. This is a local acknowledgement at the annunciator only; no message is sent to the panel.				

**Table 21 ACS Group I**

**Note:** Point number to Detector number relationship is sequential; therefore, point 48 is Detector 048.

**ACS Selection Group J (SLC #1):**

Point	Type	Red LED	Yellow LED	Switch Function*
1	Input	Detector 065 Alarm	Detector 065 Trouble	Not Used
2	Input	Detector 066 Alarm	Detector 066 Trouble	Not Used
3	Input	Detector 067 Alarm	Detector 067 Trouble	Not Used
to		to (see note)	to (see note)	
64	Input	Detector 128 Alarm	Detector 128 Trouble	Not Used
* Pressing the switch button when the Switch Function is “Not Used” will cause the associated LED to stop blinking. This is a local acknowledgement at the annunciator only; no message is sent to the panel.				

**Table 22 ACS Group J**

**Note:** Point number to Detector number relationship is sequential. To determine Point to Detector relationship add **64** to Point number to arrive at Detector number.

**ACS Selection Group K (SLC #2):**

Point	Type	Red LED	Yellow LED	Switch Function*
1	Input	Detector 065 Alarm	Detector 065 Trouble	Not Used
2	Input	Detector 066 Alarm	Detector 066 Trouble	Not Used
3	Input	Detector 067 Alarm	Detector 067 Trouble	Not Used
to		to (see note)	to (see note)	
64	Input	Detector 128 Alarm	Detector 128 Trouble	Not Used
* Pressing the switch button when the Switch Function is “Not Used” will cause the associated LED to stop blinking. This is a local acknowledgement at the annunciator only; no message is sent to the panel.				

**Table 23 ACS Group K**

**Note:** Point number to Detector number relationship is sequential. To determine Point to Detector relationship add **64** to Point number to arrive at Detector number.

**ACS Selection Group L (SLC #1 and #2):**

Point	Type	Red LED	Yellow LED	Switch Function*
1	Input	SLC 1, Detector 129 Alarm	SLC 1, Detector 129 Trouble	Not Used
2	Input	SLC 1, Detector 130 Alarm	SLC 1, Detector 130 Trouble	Not Used
3	Input	SLC 1, Detector 131 Alarm	SLC 1, Detector 131 Trouble	Not Used
to		to (see note 1)	to (see note 1)	
31	Input	SLC 1, Detector 159 Alarm	SLC 1, Detector 159 Trouble	Not Used
32	Not Used			
33	Input	SLC 2, Detector 129 Alarm	SLC 2, Detector 129 Trouble	Not Used
34	Input	SLC 2, Detector 130 Alarm	SLC 2, Detector 130 Trouble	Not Used
35	Input	SLC 2, Detector 131 Alarm	SLC 2, Detector 131 Trouble	Not Used
		to (see note 2)	to (see note 2)	
63	Input	SLC 2, Detector 159 Alarm	SLC 2, Detector 159 Trouble	Not Used
64	Not Used			
* Pressing the switch button when the Switch Function is “Not Used” will cause the associated LED to stop blinking. This is a local acknowledgement at the annunciator only; no message is sent to the panel.				

**Table 24 ACS Group L**

**Note:** 1- Point number to Detector number relationship is sequential. To determine Point to Detector relationship add **128** to Point number to arrive at Detector number.

**Note:** 2- Point number to Detector number relationship is sequential. To determine Point to Detector relationship add **96** to Point number to arrive at Detector number.

**ACS Selection Group M:**

Point	Type	Red LED	Yellow LED	Switch Function
1	Output	Module P1.1 Active	Module P1.1 Trouble	Controls Module P1.1
2	Output	Module P1.2 Active	Module P1.2 Trouble	Controls Module P1.2
to		to (see note)	to (see note)	
8	Output	Module P1.8 Active	Module P1.8 Trouble	Controls Module P1.8
9	Output	Module P2.1 Active	Module P2.1 Trouble	Controls Module P2.1
10	Output	Module P2.2 Active	Module P2.2 Trouble	Controls Module P2.2
to		to (see note)	to (see note)	
16	Output	Module P2.8 Active	Module P2.8 Trouble	Controls Module P2.8
17	Output	Module P3.1 Active	Module P3.1 Trouble	Controls Module P3.1
18	Output	Module P3.2 Active	Module P3.2 Trouble	Controls Module P3.2
to		to (see note)	to (see note)	
24	Output	Module P3.8 Active	Module P3.8 Trouble	Controls Module P3.8
25	Output	Module P4.1 Active	Module P4.1 Trouble	Controls Module P4.1
26	Output	Module P4.2 Active	Module P4.2 Trouble	Controls Module P4.2
to		to (see note)	to (see note)	
32	Output	Module P4.8 Active	Module P4.8 Trouble	Controls Module P4.8
33	Output	Module P5.1 Active	Module P5.1 Trouble	Controls Module P5.1
34	Output	Module P5.2 Active	Module P5.2 Trouble	Controls Module P5.2
to		to (see note)	to (see note)	
40	Output	Module P5.8 Active	Module P5.8 Trouble	Controls Module P5.8
41	Output	Module P6.1 Active	Module P6.1 Trouble	Controls Module P6.1
42	Output	Module P6.2 Active	Module P6.2 Trouble	Controls Module P6.2
to		to (see note)	to (see note)	
48	Output	Module P6.8 Active	Module P6.8 Trouble	Controls Module P6.8
49	Output	Module P7.1 Active	Module P7.1 Trouble	Controls Module P7.1
50	Output	Module P7.2 Active	Module P7.2 Trouble	Controls Module P7.2
to		to (see note)	to (see note)	
56	Output	Module P7.8 Active	Module P7.8 Trouble	Controls Module P7.8
57	Output	Module P8.1 Active	Module P8.1 Trouble	Controls Module P8.1
58	Output	Module P8.2 Active	Module P8.2 Trouble	Controls Module P8.2
to		to (see note)	to (see note)	
64	Output	Module P8.8 Active	Module P8.8 Trouble	Controls Module P8.8

**Table 25 ACS Group M**

**Note:** Point number to Panel Circuit Module number relationship is sequential within “P” groups. Point 14 is Module P2.6; point 29 is P4.5; point 55 is P7.7, etc.

**ACS Selection Group N**

This group is the same as Group A ( See Table 13 on page 35 ), with the following exceptions:

- It should be selected only for TM-4s used for remote station communication.
- Selection Group N follows the alarm relay for annunciation (Selection Group A annunciates immediately).
- The yellow LED of annunciator point 2 is for Alarm Silence only (in Selection Group A it is for Signal Silenced).

**ACS Selection Group O**

This group is the same as Group A ( See Table 13 on page 35 ), with the following exceptions:

- It should be selected for only for TM-4s used as Fire Municipal Box Trip outputs.
- Selection Group O provides a “Master Box” trouble displayed at the panel.
- Selection Group O follows the alarm relay for annunciation (Selection Group A annunciates immediately).
- The yellow LED of annunciator point 2 is for Alarm Silence only (in Selection Group A it is for Signal Silenced).



## How to Check the Program for Errors (8=CHECK PRG)

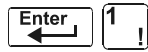

Program Change  
Password

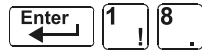

When finished programming, you can use the Check option to search the program entries for possible errors. From the “Basic Program” screen, press the **8** key. The Check option searches the program for the following conditions that can cause errors:

- Output points mapped to a zone without a mapped input
- A zone with mapped input points without mapped output points (including Z00 outputs)
- Releasing zone inputs (R0-R9) with no RELEASE CKT outputs mapped to them; or RELEASE CKT outputs with no R0-R9 inputs mapped to them
- R0-R9 inputs not mapped to MAN. RELEASE.

**Note:** For more information on Releasing Zone, refer to “Appendix A: Releasing Applications” on page 53.

If the Check option detects multiple devices that fail the check, press the PREVIOUS or NEXT key to step through the devices. If the Check option displays errors, return to Point Programming (“How to Modify or Delete a Point (2=point)” on page 21) and correct the errors. The figure below shows a sample display of program screen that appears after a successful program check:

```
PROGRAM CHECK OK.
RE-TEST PANEL NOW      08:34A 110700 Tue
```

## How to Use the Network Program



Program Change  
Password



From the “Program Change Selection” screen, press the **2** key to display the “Network” screen, which displays as follows:

```
THRESHOLD CH.A:H, THRESHOLD CH.B:H,
NODE: .000, STYLE?:N, <ENTER>
```

**THRESHOLD CH.A:** - Enter H or L, for high or low threshold setting for channel A on the NCM module.

**THRESHOLD CH.B:** - Enter H or L, for high or low threshold setting for channel B on the NCM module.

**NODE:** - Enter the panel’s network node number. The valid network node number range is 1-103. The number will be entered after the decimal point; the spaces before the decimal point are for future use.

**STYLE7:** - Enter N for network style determination (either Style 4 or Style 7) through autoprogramming. Enter Y to force a Style 7 designation for network wiring.

**Note:** If network Style 7 wiring is determined by autoprogramming, a change in the wiring (for example, a break in the network wiring) would cause the system to reassess the network wiring style as 4. If network Style 7 wiring is forced, a break in the wiring will create a trouble message.

### How to Select the Network Program Options

To select network options, follow these steps:

1. Using the arrow keys, move the blinking cursor to a selection.
2. Press the NEXT or PREVIOUS key to select **H** or **L** (Threshold Ch. A, Threshold Ch. B), a three-digit number (Node), or **Y** or **N** (Style 7).

When finished making selections, press the ESC key three times to return the control panel to normal operation.

When programming is complete, the panel must be reset to register the programming.

## How to Use the Utility Program

### Utility Program Options



From the “Program Change Selection” screen, press the **3** key to display the “Utility Program” screen as shown below:

Program Change  
Password



```
DYN.POLL=N TBL.REMIND=2 ALA.SCROLL=Y
LOCAL CONTROL=Y
```

Descriptions of the four (4) options on the Utility Program screen:

Utility Option	Description
DYN.POLL Dynamic Poll	<p>This option determines the polling speed for the SLC, which you can select as follows:</p> <ul style="list-style-type: none"> <li>• Select <b>Y</b> if you want to optimize the SLC for a harsh noise environment</li> <li>• Select <b>N</b> to optimize the response speed of the SLC (default).</li> </ul>
TBL.REMIND TBL Reminder	<p>This option provides trouble resound selections to meet the requirements of NFPA 72-1999, which you can select as follows:</p> <ul style="list-style-type: none"> <li>• Select <b>*</b> if you don't want a trouble reminder</li> <li>• Select <b>1</b> to sound a short trouble reminder tone every minute</li> <li>• Select <b>2</b> to resound a trouble tone every 24 hours at 11:00 AM, and to send a reminder every sixty seconds for acknowledged troubles</li> <li>• Select <b>3</b> to display a detector while in the alarm verification mode and no trouble reminder</li> <li>• Select <b>4</b> for once a minute trouble reminder with alarm verification display</li> <li>• Select <b>5</b> for trouble reminder resound every 24 hours at 11:00 AM with alarm verification display, and to send a reminder every sixty seconds for acknowledged troubles</li> </ul>
ALA.SCROLL Alarm Scroll	<p>This option allows you to select how alarms are displayed.</p> <ul style="list-style-type: none"> <li>• Select <b>Y</b> if you want each alarm displayed for approximately two seconds (default)</li> <li>• Select <b>N</b> if you want only the first alarm and the alarm count displayed</li> </ul>
LOCAL CONTROL	<p>This option allows you to disable local control of the ACKNOWLEDGE/SCROLL DISPLAY key, SIGNAL SILENCE key and SYSTEM RESET key. You can select local control as follows:</p> <ul style="list-style-type: none"> <li>• Select <b>N</b> to disable local control</li> <li>• Select <b>Y</b> to enable local control (default)</li> </ul> <p><b>Note:</b> If the panel is to be controlled exclusively by a Display and Control Center (DCC), Local Control should be disabled.</p>

**Table 26 Utility Program Options**

### How to Select Utility Program Options

To select utility options, follow these steps:

1. Using the arrow keys, move the blinking cursor to a selection.
2. Press the NEXT or PREVIOUS key to select **Y** or **N** (Dynamic Poll, Alarm Scroll, or Local Control); or **\***, **1**, **2**, **3**, **4**, **5** (TBL Reminder).
3. When finished making selections, press the ESC key three times to return the control panel to normal operation.

## How to Use FlashScan Poll



From the “Program Change Selection” screen, press the **4** key to access the “FlashScan Poll” selection screen as shown below:

Program Change  
Password



FLASHSCAN	L1DET	L1MOD	L2DET	L2MOD
	N	N	N	N

This menu allows the selection of CLIP (Classic Loop Interface Protocol) or FlashScan detectors and modules for each loop. Once this screen is accessed, the cursor will be positioned underneath the Loop #1 Detector selection, blinking the currently selected protocol type. The default selections are shown in the above figure. This indicates that both Loop #1 and Loop #2 detectors and modules are selected to use CLIP devices. If FlashScan devices are to be employed, change the blinking cursor by pressing the **Y** key or toggle it by using the PREVIOUS or NEXT key. After the selections have been made to the detectors and modules of both loops, press the ENTER key, at which time the panel will reset.

FlashScan devices can be programmed to run in either CLIP or FlashScan mode. Observe one of the following three options when using FlashScan devices:

- Option 1** Program all modules and detectors on an SLC as FlashScan.  
(In the “FlashScan Poll” screen, enter Y for DET and Y for MOD. It is possible to have up to 159 FlashScan modules and 159 FlashScan detectors on this SLC.)
- Option 2** Program all modules and detectors on an SLC as CLIP.  
(In the “FlashScan Poll” screen, enter N for DET and N for MOD. It is possible to have up to 99 CLIP modules and 99 CLIP detectors on this SLC.)
- Option 3** Program all detectors as CLIP and all modules as FlashScan on an SLC.  
(In the “FlashScan Poll” screen, enter N for DET and Y for MOD. It is possible to have up to 99 CLIP detectors and 159 FlashScan modules on this SLC.)



**CAUTION:** Do not program modules as CLIP and detectors as FlashScan on the same SLC. This combination is not an option: Y for DET, N for MOD in the “FlashScan Poll” screen.

Refer to the SLC manual for available devices.

## Baud Rate of Serial Ports

### Printer Serial Port

The default baud rate of the RS-232 serial printer port is 9600. To change baud rate to 2400, follow these steps:

1. From the SYSTEM NORMAL screen, press the ENTER key to display the Program Entry screen, as shown below:



```

┆=PROGRAMMING      2=READ STATUS ENTRY
(ESCAPE TO ABORT)
  
```

2. Press the **1** key. The control panel displays the Enter Password screen, as shown below:

```

ENTER PROG OR STAT PASSWORD, THEN ENTER.
_ (ESCAPE TO ABORT)
  
```

3. Enter **2400B** and press . The five asterisks that appear when you type in the baud rate will disappear when you press .
4. Press  twice to return to the SYSTEM NORMAL screen.
5. To switch from 2400 baud to 9600 baud repeat steps 1, 2, and 3 entering "9600B".

### CRT Serial Port

The default setting for the serial RS-232 CRT port is "disabled". To enable the RS-232 CRT port at 9600 baud, follow the steps below.

**Note:** The serial RS-232 CRT port can only be enabled in standalone (non-networked) applications. The only baud rate supported is 9600.

1. From the SYSTEM NORMAL screen, press the ENTER key to display the Program Entry screen, as shown below:



```

┆=PROGRAMMING      2=READ STATUS ENTRY
(ESCAPE TO ABORT)
  
```

2. Press the **1** key. The control panel displays the Enter Password screen, as shown below:

```

ENTER PROG OR STAT PASSWORD, THEN ENTER.
_ (ESCAPE TO ABORT)
  
```

3. Enter **CRT96** and press . The five asterisks that appear when you type in the code will disappear when you press .
4. Press  twice to return to the SYSTEM NORMAL screen.
5. To switch back to the default network mode (no CRT) repeat steps 1, 2, and 3 entering "NOCRT".

# 3. Status Change

## What is Status Change?

Status Change provides a second programming level - accessed by an assigned password - for changing operating parameters. (These operating parameters do not affect control program settings.) For example, the Status Change password lets you change settings such as: detector sensitivity, system time and date, and so on.

**Note:** Assign the Status Change password to persons who do not have access to Level 1 programming options.

## How to Enter Status Change

To enter Status Change, follow these steps:

1. From the "SYSTEM NORMAL" screen, press the ENTER key. The control panel displays the "Entry" screen, as shown below:

```
1=PROGRAMMING      2=READ STATUS ENTRY
```

2. From the "Entry" screen, press the 1 key. The control panel displays the "Enter Password" screen as shown below:

```
ENTER PR0G 0R STAT PASSW0RD, THEN ENTER.
```

3. Enter your Status Change password (See "How to Enter a Password", page 13). The control panel displays the "Status Change Selection" screen, as shown below:

```
STATUS CHANGE PRESS: 1=DISABL 2=SENSITIV  
3=CLR VER 4=CLR HIST 5=TIME 6=WALK TEST
```

4. Select a Status Change selection: **1,2,3,4,5**, or **6**.

### Status Change Options

**Option 1=DISABL** - The Disable/Enable option lets you disable programmed points for detectors, modules, zones and NAC/Panel Circuit modules. For details, refer to "How to Disable or Enable a Point" on page 47.

**Option 2=SENSITIV** - The Detector Sensitivity option lets you change the Alarm and Pre-alarm (sensitivity) level for an installed detector. For details, refer to "How to Change Sensitivity for a Detector" on page 48.

**Option 3=CLR VER** - The Clear Verification screen lets you clear all counters for detectors selected for Alarm Verification. For details, refer to "How to Clear Alarm Verification Counters" on page 49.

**Option 4=CLR HIST** - The Clear History screen lets you clear the entire History buffer from memory. For details, refer to "How to Clear the History Buffer" on page 49.

**Option 5=TIME** - The Time/Date option lets you set the time and date for the system clock. For details, refer to "How to Set the System Time and Date" on page 49.

**Option 6=WALK TEST** - The Walk Test option lets you test the entire fire alarm system while away from the control panel. For details, refer to "How to Do a Walk Test" on page 50".

## How to Disable or Enable a Point



Status Change  
Password

The Disable/Enable option lets you disable programmed points for detectors, modules, zones, and NACs and Panel Circuits. The program allows you to disable an initiating device in alarm: however, the disable will not take effect until after the panel has been reset.



1. From the “Status Change Selection” screen, press the 1 key to display the “Disable/Enable” screen.
2. Select the point type:

- for detectors
- for modules
- for NAC and Panel Circuits
- for zones

The cursor will blink the first SLC address digit in the detector, zone, module, or NAC/Panel Circuit field.

**WARNING: Disabling a zone disables all input and output devices that use the zone as the first entry in the CBE list.**

3. Enter the address of the point, then press the ENTER key. A sample display follows:

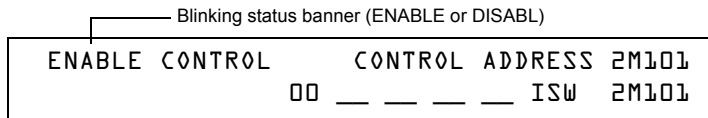

When you disable a point and press the ESC key to return to the Disable/Enable screen, the control panel: a) turns on the POINT DISABLED LED; b) sounds the panel sounder; and c) changes the status banner to TROUBL for the point.

You can disable or enable a point by changing the status banner as follows:

To	Press
Change the status	Maneuver the cursor with the arrow keys until it is in the status field. Press <div style="display: flex; justify-content: center; gap: 20px; align-items: center;"> <span> (Next Selection)</span> <span>or</span> <span> (Previous Selection)</span> </div>
Save the status	
Go to the next or previous point address	<div style="display: flex; justify-content: center; gap: 20px; align-items: center;"> <span> (Next Selection)</span> <span>or</span> <span> (Previous Selection)</span> </div>

## How to Change Sensitivity for a Detector

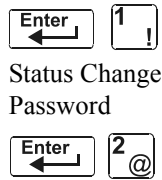

The Detector Sensitivity option lets you change the Alarm and Pre-Alarm (sensitivity) level for an installed detector. From the “Status Change Selection” screen, press the **2** key to display the “Detector Selection” screen as shown below:

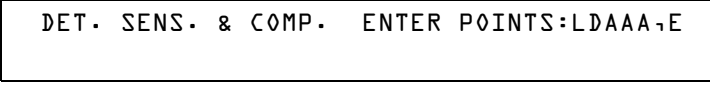

### How to Select a Detector

Enter the SLC address (2D101) of an installed detector in the “LDAAA” field (shown above). The control panel displays the following screen:

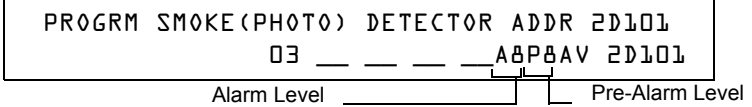

### How to Use the Detector Sensitivity Screen

Use the instructions below to set/change detector sensitivity, display additional detectors, and set Pre-alarm values.

**Note:** If not using Pre-Alarm, set PA=0. PA=1 is the self-optimizing mode. For details, refer to “How to Select a Pre-Alarm Level” on page 89.

To	Enter or Press
Display detector information on the screen.	The detector address, then press .
Set alarm sensitivity level.	A value (1-9) or increase or decrease values by pressing the NEXT or PREVIOUS keys:  or .
Set Pre-alarm level	A value (0-9) or increase or decrease values by pressing the NEXT or PREVIOUS keys:  or .
Save the sensitivity values.	
Display the next existing detector address.	(Next Selection)
Display the previous existing detector address.	(Previous Selection)



## How to Clear Alarm Verification Counters

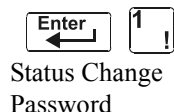

The Clear Verification screen lets you clear all counters for detectors selected for Alarm Verification. From the “Status Change Selection” screen, press the 3 key to display the “Clear Verification” screen as shown below:



PRESS ENTER TO CLEAR VERIFICATION COUNTS  
OR ESCAPE TO ABORT

From the Clear Verification screen, you can do the following:

- Press the ENTER key to clear all verification counters and return to the “Status Change Selection” screen; or
- Press the ESC key to return to the “Status Change Selection” screen without clearing.

## How to Clear the History Buffer

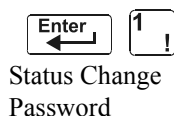

The Clear History screen lets you clear the entire History buffer from memory. Press the 4 key from the “Status Change Selection” screen to display the “Clear History” screen as shown below:



PRESS ENTER TO CLEAR HISTORY FILE  
OR ESCAPE TO ABORT

From the Clear History screen, you can do the following:

- Press the ENTER key to clear the contents of the History buffer and return to the “Status Change Selection” screen; or
- Press the ESC key to return to the “Status Change Selection” screen without clearing.

## How to Set the System Time and Date

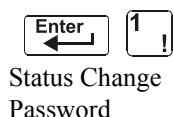

The Time/Date option lets you set the time and date for the system clock. Press the 5 key from the “Status Change Selection” screen to display the “Time/Date” screen as shown below:

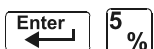

CHANGE TIME/DATE  
11:40A Wed 07/14/2001

The first digit flashes until you change the value or press the ENTER key. To set the system time and date, follow the instructions below:

To	Do this
Change the time and date values	Enter values from the numeric keys on the keypad.
Change A (AM) or P (PM)	Press  (Next Selection) or  (Previous Selection)
Change the day	Press  (Next Selection) or  (Previous Selection)
Move to another digit	Press
Save the time and date and return	Press

## How to Do a Walk Test

Walk Test allows the user to test the entire fire alarm system. There are two kinds of Walk Test - Basic and Advanced, described later in this section.

Before entering Walk Test, note the following:

- For each individual activation, the control panel sends “TEST Axx”(for alarm testing) or TEST Txx (for trouble testing) to the History buffer, installed printers and CRT-2s so results can be reviewed.
- Basic Walk Test, Silent – In order to keep the test silent, do not program any of the output modules with “W” in the Walk Test field .
- Advanced Walk Test - This test overrides a setting of “\*” (silent) in the Walk Test field. All activated outputs will sound until panel reset.
- The control panel provides a 1-hour timer for Walk Test mode. When the hour expires with no activity, the control panel automatically returns to normal operation.
- Walk Test may be exited at any time by pressing the ESC key.



**WARNING: Walk Test mode deactivates fire protection. Observe the following:**

- Prior to Walk Test, secure all protected buildings, and notify the building owner/operator, fire department, and other pertinent personnel that testing is in progress.
- Immediately after Walk Test is completed, notify the same people that testing is complete and is restored to normal operation.

For information on programming Walk Test field selections, refer to “How to Modify an Addressable Control Module Point” on page 24 or “How to Modify NAC and Panel Circuit Points” on page 25.

### Basic Walk Test

When the tester activates an input during Basic Walk Test , all silenceable outputs mapped by CBE to that input will activate. The activations are tracking; once the activation stimulus is removed, the input will deactivate. Basic Walk Test may be audible or silent, depending on the Walk Test setting of participating outputs. Program the Walk Test field for control modules, NAC, and Panel Circuits as follows:

For	Program Silenceable Outputs with	Silenceable Outputs will
an audible Basic Walk Test	W	sound for approximately 4 seconds during Walk Test
a silent Basic Walk Test	*	not sound during Walk Test
a trouble Basic Walk Test	W	sound for approximately 8 seconds when put into trouble

Enter Basic Walk Test in the following manner:



From the “Status Change Selection” screen, press the **6** key. The control panel displays the “Walk Test” screen as shown below:



Status Change  
Password



WALK TEST	PRESS ENTER TO START
ESCAPE TO ABORT	

**Note:** The control panel cannot be put into Walk Test from an alarm condition.

Operate the control panel in Walk Test as follows

To	Press
Put the control panel into Walk Test mode	
Stop a Walk Test and return to the "Status Change Selection" screen	

Basic Walk Test directs the control panel to do the following:



- Activate silenceable outputs associated by programming with each new alarm. (The panel does not activate non-silenceable outputs.)
- Save and store each test in the History buffer
- Send a TEST Axx status banner for each alarm, and a TEST TXX banner for each trouble, to the printer (xx equals the number of tests for a detector or input device with this address)
- Turn on the System Trouble LED
- Turn on the System Trouble relay
- Disable activation of the System Alarm relay

### Advanced Walk Test

During Advanced Walk Test, when the tester activates an input, all CBE mapped to that input will activate with the exception of releasing functions. Each input activation is latching; that is, it will not deactivate until the system is reset. Advanced Walk Test will sound all activated outputs, overriding a setting of "\*" (silent) in the Walk Test field.

**Note:** Some detectors, laser detectors for example, can be difficult to place in alarm using a magnet. Advanced Walk Test facilitates magnet testing of these detectors.

Enter Advanced Walk Test as follows:

  Enter LTEST at the password screen. Asterisks will display where LTEST has been typed. Pressing ENTER displays the following screen.

LTEST



TROUBL IN SYSTEM    ADV WALK TEST PROCESSING DISABLED 10:07a 051903 MON
--

**Note:** The control panel cannot be put into Walk Test from an alarm condition.

To	Press
Stop an Advanced Walk Test and return to the "Status Change Selection" screen	

Advanced Walk Test directs the control panel to do the same as it does for Basic Walk Test (see "Basic Walk Test" above) with the following exceptions:

- alarm and trouble messages are sent to the printer, not test messages. (These Walk Test messages can be distinguished from others at the printer because they begin with the trouble message generated when Walk Test is entered, and end with the cleared trouble when Walk Test is exited.)
- all CBE mapped to the test input is activated except releasing functions.

### Walk Test Activation Indications

Walk Test Activation Indications

FlashScan poll mode - Once the test is started:

- each intelligent addressable input device will blink its address in red, and each intelligent addressable output device will blink its address in green. Pattern examples are given below.

Address	Blink Pattern
8	8 blinks, long stop, 8 blinks, long stop,....

37	3 blinks, stop, 7 blinks, long stop, 3 blinks, stop, 7 blinks, long stop,....
70	7 blinks, stop, 10 blinks, long stop, 7 blinks, stop,.....
107	10 blinks, stop, 7 blinks, long stop, 10 blinks, stop,.....
152	15 blinks, stop, 2 blinks, long stop, 15 blinks, stop, 2 blinks, long stop....

- an input device activated in Basic Walk Test latches on steady green for the duration of the test.
- an output device activated in Basic Walk Test will remain active and the LED will glow steady green for
  - approximately 4 seconds for alarms
  - approximately 8 seconds for troubles.
- an output device activated in Advanced Walk Test will remain active and the LED will glow steady green until the reset key is pressed.

**CLIP mode** - Once the test is started:

- intelligent addressable input and output devices continue to blink red as usual until activated.
- an input device activated in Basic Walk Test latches on steady red during activation. If the device is put in trouble (for instance, the detector head is removed, then replaced), the LED will be latched on for the duration of the test.
- an output device activated during Basic Walk Test will remain active and the LED will glow steady green (if a FlashScan module) or steady red (if a CLIP module) for
  - approximately 4 seconds for alarms
  - approximately 8 seconds for troubles.
- an output device activated in Advanced Walk Test will remain active and the LED will glow steady green (if a FlashScan module) or steady red (if a CLIP module) until the reset key is pressed.

### Viewing Walk Test Results

When finished with a Walk Test, view the History buffer, installed printers and CRT-2s to check the results of the Walk Test. View the History buffer by using the Read Status function. From the SYSTEM NORMAL screen, press the ENTER key, press the 2 key two times, then press the ENTER key to view the History buffer. For further instructions on using the Read Status function, refer to the *NFS-640 Operations Manual*.

# Appendix A: Releasing Applications



**WARNING:** When used for CO<sub>2</sub> releasing applications, observe proper precautions as stated in NFPA 12. Do not enter the protected space unless physical lockout and other safety procedures are fully completed.

Do not use software disable functions in the panel as lockout.

Do not enable the BACKUP option switch for any of the four Notification Appliance Circuits (NACs) if they are used for releasing functions.

## What are Releasing Zones?

The control panel includes ten Releasing Zones (R0-R9) that can be used to control up to ten releasing operations. Each zone operates independently, and is fully programmable.

**Note:** Releasing Zones R0-R9 appear in the CBE list of devices as ZR0-ZR9. For example, if you list R5 for a detector, one of the five zones in the CBE list of the detector will display as ZR05.

From the “Special Function Change” screen (refer to “How to Program Special Zones (6=SPL FUNCT)” on page 29), select a Releasing Zone (R0-R9) to display the “Releasing Function” screen:

```

PRG RELEASE FUNCTION RELEASE CONTROL
DELAY=30 ABORT=ULI CROSS=N SOAK=0000 R05
    
```

Each Releasing Zone includes four releasing functions, outlined below:

Function	Lets You
Delay	Program a 0160-second Delay Timer (or 00, no delay). The Delay Timer equals the time that must elapse between activating an initiating device and activating the releasing zones mapped to the active initiating device. Refer to “How to Program a Delay Timer” on page 54.
Abort	Select a 3-letter Abort switch Type Code (ULI, IRI, NYC, or AHJ) that adds a delay time to a Releasing Zone, or prevents a release of a Releasing Zone. Refer to “How to Program an Abort Switch” on page 54.
Cross	Select one of three Cross Zone types or “N” (not used). A Cross Zone requires tripping two or more devices to activate the outputs mapped to one of the Releasing Zones. Refer to “Using Cross Zones” on page 62.
Soak	Select a Soak Timer (0001-9999 seconds) or “0000” (not used). Refer to “How to Program a Soak Timer (NFPA 16 Applications Only)” on page 64.

## NFPA Releasing Applications

This control panel can be used for agent release or preaction/deluge control applications. In a properly configured system with compatible, listed actuating and initiating devices, this control panel complies with the following NFPA standards for installation in accordance with the acceptable standard:

Standard	Covers
NFPA 12	CO2 Extinguishing Systems
NFPA 12A	Halon 1301 Extinguishing Systems
NFPA 13	Sprinkler Systems, Installation of
NFPA 15	Water Spray Fixed Systems
NFPA 16	Foam-water Deluge and Foam-water Spray Systems
NFPA 17	Dry Chemical Extinguishing Systems
NFPA 17A	Wet Chemical Extinguishing Systems
NFPA 2001	Clean Agent Fire Extinguishing Systems

**Table 27 NFPA Standards for Releasing Applications**

## How to Program a Releasing Zone

This section provides details for programming the releasing functions: Delay Timer, Abort Switch, Cross Zone, and Soak Timer.

### How to Program a Delay Timer

Use a Delay Timer to specify the elapsed time between alarm activation of an initiating device and activation of all output devices programmed as release circuits and mapped to that initiating device. You can set the Delay Timer from 01 to 60 seconds, or to 00 for no delay. The figure below shows graphical representation of a 15-second timer:

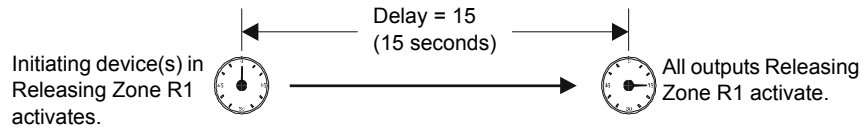

**Figure 3 Example of 15-Second Delay Timer**

To Program	Do this
Delay Timer	Enter a value (00-60) from the numeric keys on the keyboard.

Press  at this point to save the Delay Timer value if no other fields on the screen are changing. To change another field on the screen, move the cursor into position by pressing the arrow keys.

### How to Program an Abort Switch

#### Definition of Abort Switches

The control panel provides for four (4) types of Abort Switches (ULI, IRI, NYC, and AHJ) that you can use, that will affect the operation of a Delay Timer mapped to the same Releasing Zone. For example, an Abort Switch selected for Releasing Zone R05 only affects the Delay Timer selected for R05. Other requirements for using an Abort Switch include the following:

- Connecting a monitor module to a UL-listed abort station, such as the NBG-12LRA shown below.
- Program the monitor module with the Type Code ABORT SWITCH. (Refer to “How to Modify an Addressable Monitor Module Point” on page 23.)
- Abort switch shall not be used with a preaction system.

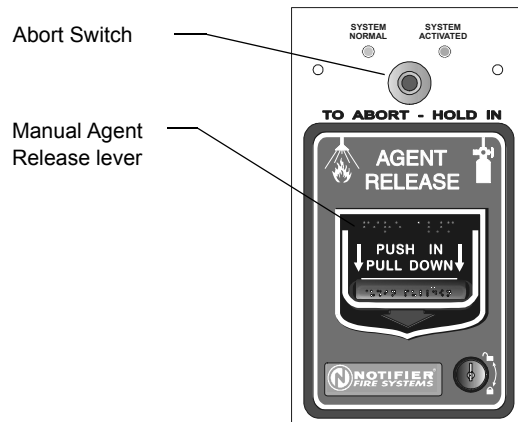

NBG12LRA station with Abort Switch

**Figure 4 UL-listed Abort Station**

This section contains information for programming each type of Abort Switch for a Releasing Zone.

**How an Abort Switch Works**

The figure below contains an example for configuring an Abort Switch and shows the requirements for using an Abort Switch for Releasing Zone R05, which are:

- A monitor module is wired to an abort station
- The monitor module is programmed with the Type Code, ABORT SWITCH
- All initiating devices and outputs are mapped to a common Releasing Zone (R05 shown)
- Releasing Zone R05 is programmed with the releasing functions: Delay, Abort, Cross, and Soak

When an initiating device activates, you must press and hold the Abort Switch or the control panel will send the command to dump releasing agents when the Delay time (15 seconds shown) expires. The Abort selection (ULI, IRI, NYC, or AHJ) determines the function of the Abort Switch.

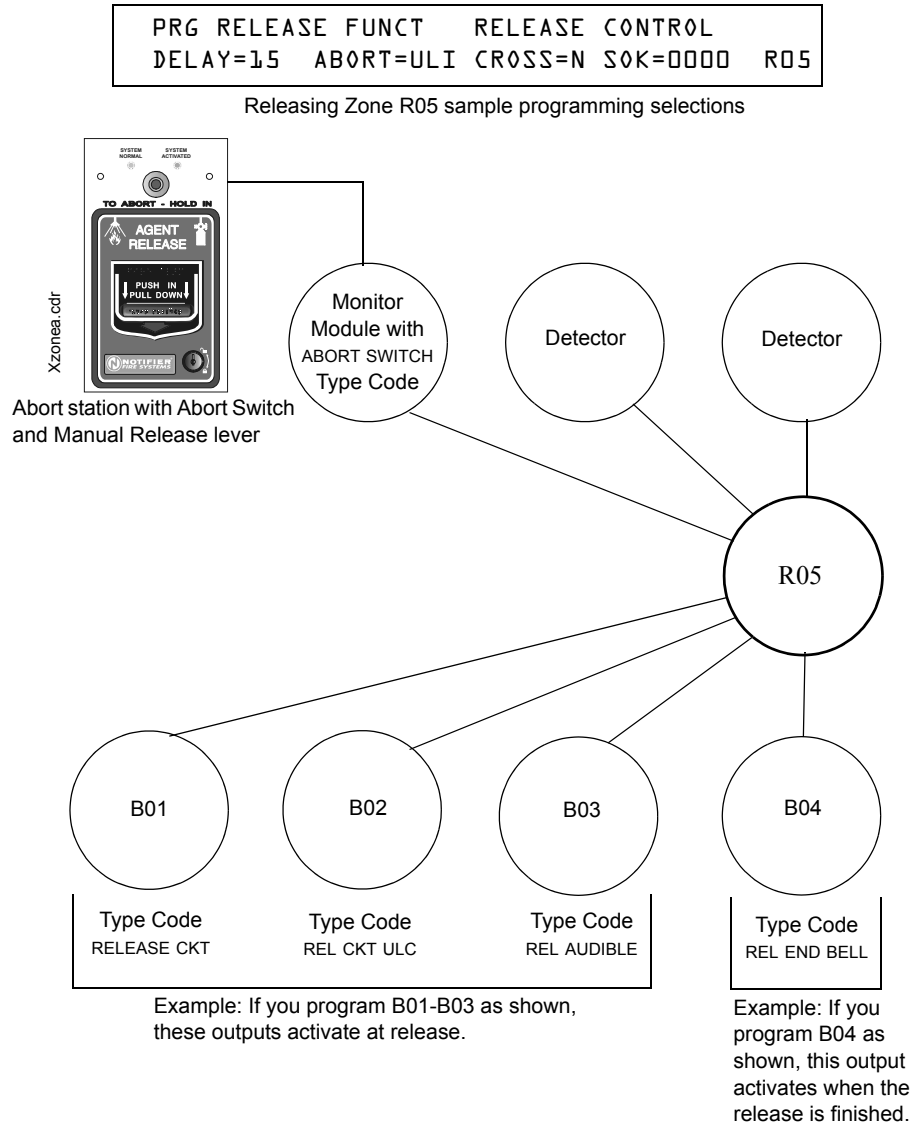

**Figure 5 Example of a Basic Configuration for an Abort Switch**

### Programming a ULI Abort Switch

The following contains information needed to program a ULI Abort Switch:

- Description** A standard UL-type delay timer that complies with UL Standard 864.
- How to program**
1. Program the monitor module connected to the abort station with the Type Code ABORT SWITCH as detailed in “How to Modify an Addressable Monitor Module Point” on page 23.
  2. Select a time for the Releasing Zone Delay Timer (refer to “How to Program a Delay Timer” on page 54).

To Program	Do this
ULI Abort Switch	Type ULI in the ABORT= field, or press the NEXT or PREVIOUS keys: <input type="button" value="+"/> or <input type="button" value="-"/> until ULI appears in the field.

3. Press  at this point to save the Abort Switch value if no other fields on the screen are changing. To change another field on the screen, move the cursor into position by pressing the arrow keys on the keypad.

**How it works** When an alarm initiates in the programmed Releasing Zone, you can press and hold the Abort Switch while the Delay Timer continues to count down. (If the delay timer has expired, the abort switch has no effect.) When you release the Abort Switch, a 10-second ULI timer counts down. At the end of the 10-second ULI timer, the control panel activates the Releasing Zone outputs.

**Example** A ULI Abort Switch and a Delay Timer programmed to Releasing Zone R05:

```

PRG RELEASE FUNCT  RELEASE CONTROL
DELAY=15  ABORT=ULI  CROSS=N  SOK=0000  R05
    
```

Program selections for Releasing Zone R05

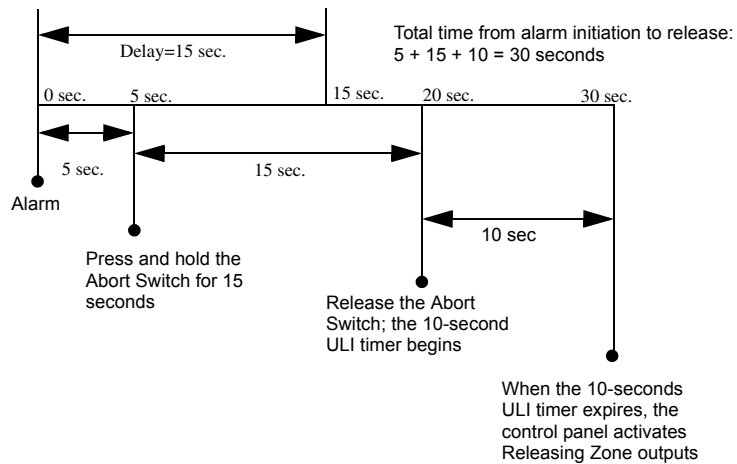

Figure 6 ULI Abort Switch Example



### Programming an IRI Abort Switch

The following contains information needed to program an IRI Abort Switch:

**Description** A standard UL-type delay timer (complies with UL Standard 864) that operates like ULI, but with additional functions for Cross Zones.

**How to program**

1. Program the monitor module connected to the abort station with Type Code ABORT SWITCH as detailed in “How to Modify an Addressable Monitor Module Point” on page 23.
2. Select a time for the Releasing Zone Delay Timer (refer to “How to Program a Delay Timer” on page 54.)

To Program	Do this
IRI Abort Switch	Type IRI in the ABORT= field, or press the NEXT or PREVIOUS keys, <input type="button" value="+"/> or <input type="button" value="-"/> , until IRI appears in the field.

3. Press  at this point to save the Abort Switch value if no other fields on the screen are changing. To change another field on the screen, move the cursor into position by pressing the arrow keys on the keypad.

**How it works**

When the first alarm occurs in a releasing zone programmed with a cross-zone code, pressing the abort switch will prevent activation of the releasing zone should a second alarm occur while the switch is held. When the abort switch is released, if a second alarm has occurred while the switch was held, the ten-second IRI timer activates immediately, and the control panel activates the releasing zone outputs at the end of the IRI timer countdown. When the abort switch is released and a second alarm has not occurred while the switch was held, the panel waits for the cross-zone conditions to be met before activating the releasing zone.



**WARNING: The IRI abort switch will only work if it is pushed before the second alarm occurs. If it is pushed after the second alarm, the releasing zone will already have been activated, and the switch will have no effect.**

**Description** A standard UL-type delay timer (complies with UL Standard 864) that operates like ULI, but with additional functions for Cross Zones.

**Example** A IRI Abort Switch and a Delay Timer programmed to Releasing Zone R05:

```

PRG RELEASE FUNCT  RELEASE CONTROL
DELAY=15 ABORT=IRI  CROSS=Z SOK=0000 R05
    
```

Program selections for Releasing Zone R05

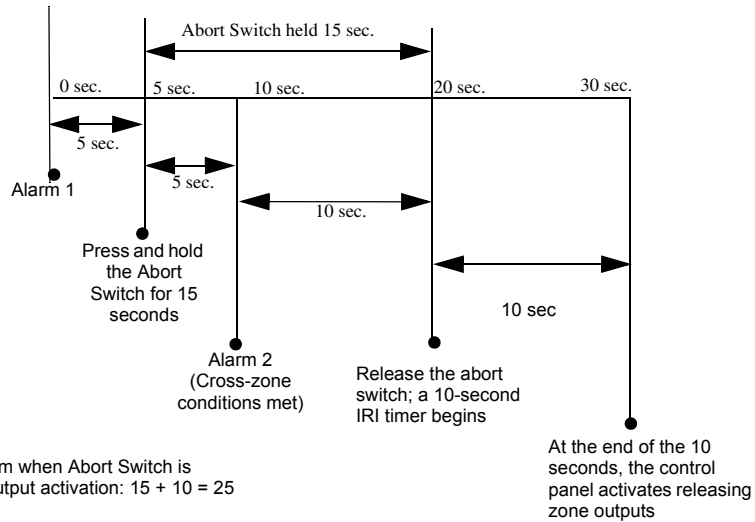

Total time from when Abort Switch is pressed to output activation: 15 + 10 = 25

Total time from when Abort Switch is released to output activation: 10 seconds

**Figure 7 IRI Abort Switch Example**

### Programming an NYC Abort Switch

The following contains information needed to program an NYC Abort Switch:

- Description** A standard NYC delay timer that adds 90 seconds to the programmed Delay Timer.
- Note:** An NYC timer does not comply with UL Standard 864.
- How to program**
1. Program the monitor module connected to the abort station with the Type Code ABORT SWITCH as detailed in “How to Modify an Addressable Monitor Module Point” on page 23.
  2. Select a time for the Releasing Zone Delay Timer (refer to “How to Program a Delay Timer” on page 54.)

To Program	Do this
NYC Abort Switch	Type NYC in the ABORT= field, or press the NEXT or PREVIOUS keys, <input type="button" value="+"/> or <input type="button" value="-"/> , until NYC appears in the field.

3. Press  at this point to save the Abort Switch value if no other fields on the screen are changing. To change another field on the screen, move the cursor into position by pressing the arrow keys on the keypad.

**How it works** When an alarm initiates in the programmed Releasing Zone, pressing and holding the Abort switch stops the Delay Timer countdown. The Delay Timer restarts at the beginning of its countdown when the Abort switch is released. When the Delay Timer expires, the 90-second NYC timer starts counting down. When both timers expire, the control panel activates Releasing Zone outputs.

**Note:** 120 seconds is the maximum delay after the Abort switch is released. If the Delay Timer time plus the NYC delay time of 90 seconds exceeds 120 seconds, Releasing Zone outputs will still be activated at 120 seconds after the Abort switch is released.

**Example 1 - Delay Time Does Not Exceed 120 Seconds**

Select a Delay Timer value for R05 of 15 seconds. The Releasing Zone activates and the 15-second Delay Timer starts. Ten seconds into the Delay Timer countdown, press and hold the Abort Switch for 30 seconds, then release the Abort Switch. The control panel restarts the Delay Timer at 15 seconds and adds the NYC delay of 90 seconds. The delay timers will both expire at 105 seconds, and Releasing Zone outputs will begin releasing at that time. Following is an example of a NYC Abort Switch and a Delay Timer programmed to Releasing Zone R05:

```
PRG RELEASE FUNCTION RELEASE CONTROL
DELAY=15 ABORT=NYC CROSS=N SOK=0000 R05
```

Program selections for Releasing Zone R05

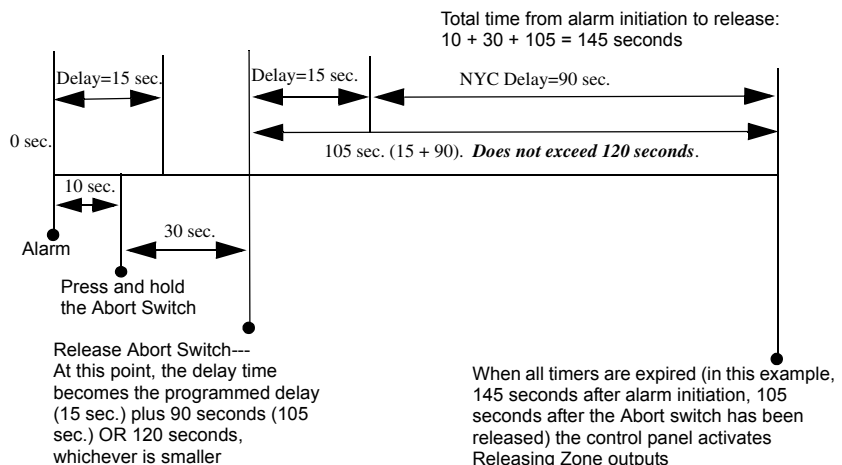

Figure 8 NYC Abort Switch Example 1

**Example 2 - Delay Time Exceeds 120 Seconds**

Select a Delay Timer value for R05 of 60 seconds. The Releasing Zone activates and the 60-second Delay Timer starts. Ten seconds into the Delay Timer countdown, press and hold the Abort Switch for 30 seconds, then release the Abort Switch. The control panel restarts the Delay Timer at 60 seconds and adds the NYC delay of 90 seconds. The delay timers will both expire at 150 seconds: however, this time exceeds the maximum of 120 seconds, so the Releasing Zone outputs will begin releasing at 120 seconds, not at 150. Following is an example of a NYC Abort Switch and a Delay Timer programmed to Releasing Zone R05:

```

PRG RELEASE FUNCTION RELEASE CONTROL
DELAY=60 ABORT=NYC CROSS=N SOK=0000 R05
    
```

Program selections for Releasing Zone R05

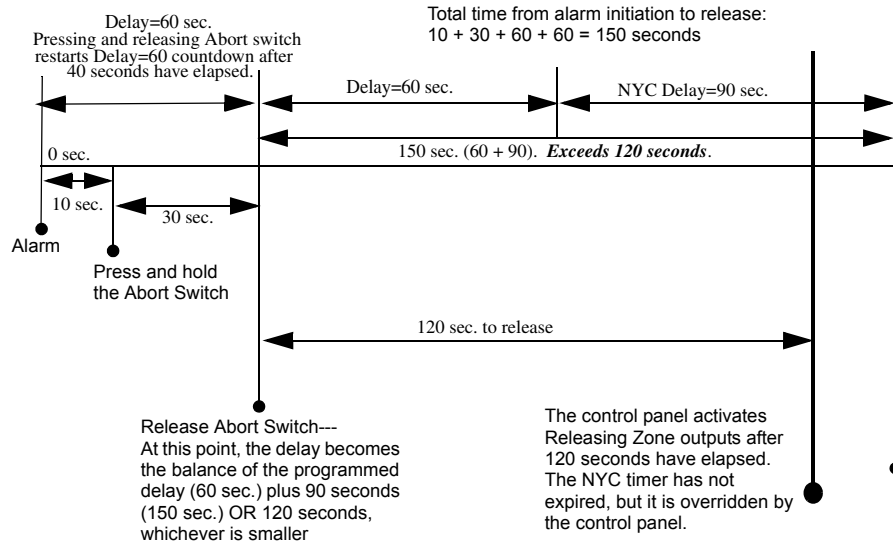

**Figure 9 NYC Abort Switch Example 2**

### Programming an AHJ Abort Switch

The following contains information needed to program an AHJ Abort Switch:

**Description** An AHJ (Authority Having Jurisdiction) delay timer that restores the programmed Delay Timer.

**Note:** An AHJ timer does not comply with UL Standard 864.

- How to program**
1. Program the monitor module connected to the abort station with the Type Code ABORT SWITCH as detailed in “How to Modify an Addressable Monitor Module Point” on page 23.
  2. Select a time for the Releasing Zone Delay Timer (refer to “How to Program a Delay Timer” on page 54.)

To Program	Do this
AHJ Abort Switch	Type AHJ in the ABORT= field, or press the NEXT or PREVIOUS keys, <input type="button" value="+"/> or <input type="button" value="-"/> , until AHJ appears in the field.

3. Press  at this point to save the Abort Switch value if no other fields on the screen are changing. To change another field on the screen, move the cursor into position by pressing the arrow keys on the keypad.

**How it works** When an alarm initiates, the programmed Delay Timer starts. Press and hold the Abort switch and the control panel suspends the Delay Timer. When you release the Abort Switch, the control panel restores the value of the programmed Delay Timer and the Delay Timer counts down. When the Delay Timer expires, the control panel activates Releasing Zone outputs.

**Example** An AHJ Abort Switch and a Delay Timer programmed to Releasing Zone R05:

```

PRG RELEASE FUNCTION RELEASE CONTROL
DELAY=60 ABORT=AHJ CROSS=N SOK=0000 R05
    
```

Program selections for Releasing Zone R05

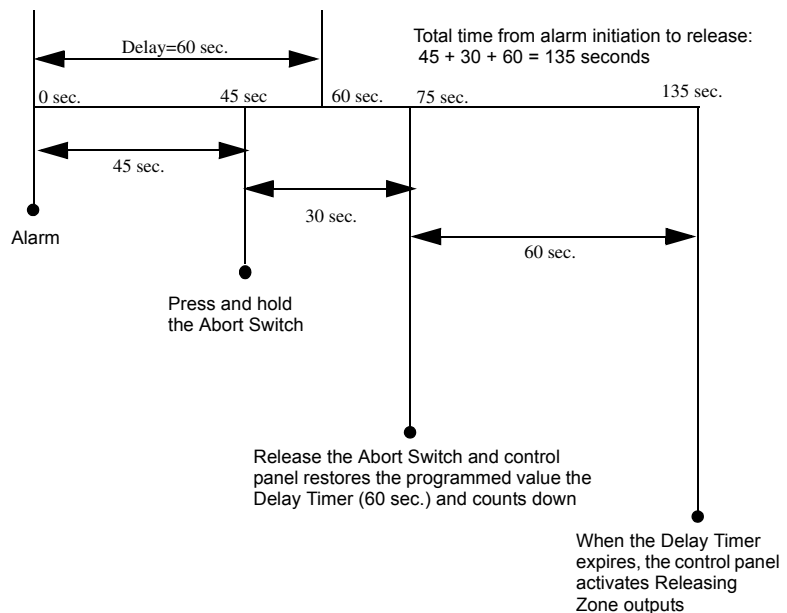

Figure 10 AHJ Abort Switch Example

## Using Cross Zones

### Purpose of Cross Zones

Using Cross Zones lets you program the control panel to activate a Releasing Zone and any output mapped to the Releasing Zone only after a predetermined sequence of events occurs. (If not using Cross Zones, set CROSS= to N.)

**Note:** Only the first Software Zone (Z01-Z99) listed in the zone map is used to determine Cross=Z.

A summary of the types of Cross Zones and the conditions for activating a Releasing Zone:

Type	Activates when
Y	Two or more detectors are alarmed that are mapped to one of the ten Releasing Zones (R0-R9).
Z	Two or more detectors are alarmed that are mapped to two different software zones and mapped to one of the ten Releasing Zones (R0-R9).
H	At least one smoke detector mapped to one of the ten Releasing Zones (R0-R9) is alarmed and at least one heat detector mapped to the same Releasing Zone (R0-R9) is alarmed.

**Note:** When in alarm, Special Zones R0-R9 appear in the CBE list as ZR00-ZR09. For example, R5 appears in the CBE list as ZR05.

### How Cross Zones Work

Below is an illustrated example of how Cross Zones work, using five Cross Zone selections (four detectors and a NAC mapped to Releasing Zone R1):

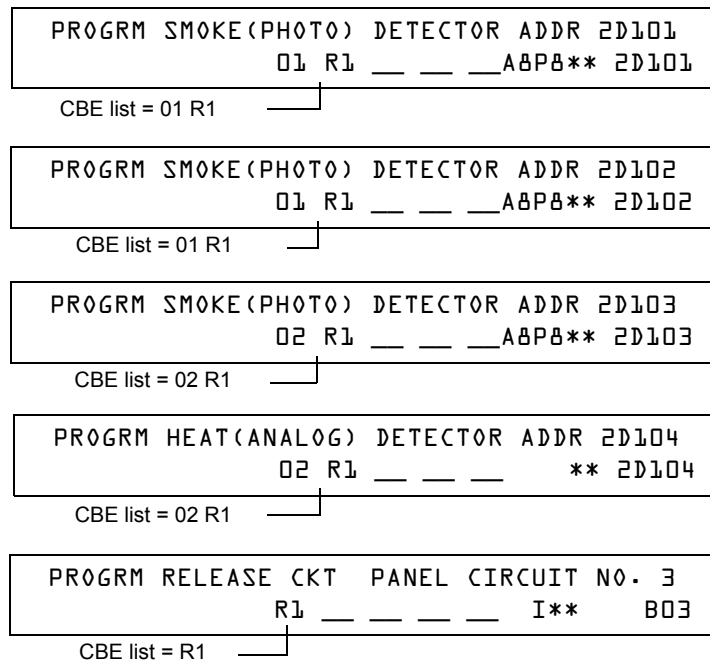

*Continued on the next page...*

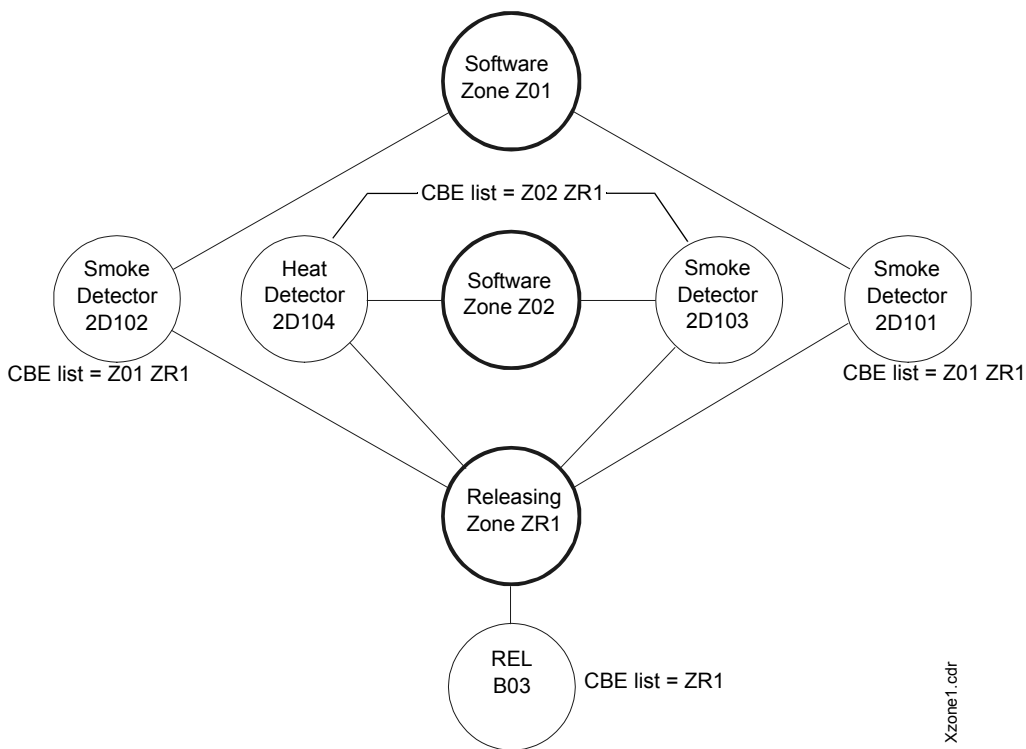

**Figure 11 Illustrated Example of Cross Zone Programming**

A listing of each Cross Zone option and the conditions required to activate the Releasing Zone, according to the example shown above.

Cross Zone Selection (Cross=)	Condition(s) Required to Activate the Releasing zone
Cross=N	An alarm from any detector activates the releasing circuit.
Cross=Y	An alarm from any two detectors activates the releasing circuit.
Cross=Z	An alarm from two detectors mapped to different Software Zones, but mapped to the same Releasing Zone. <ul style="list-style-type: none"> <li>• An alarm from 2D101 and 2D103</li> <li>• An alarm from 2D102 and 2D104</li> <li>• An alarm from 2D101 and 2D104</li> <li>• An alarm from 2D102 and 2D103</li> </ul> The two detectors listed in each set above are each mapped to different zones, but both list ZR1 in their CBE.
Cross=H	Activation of heat detector 2D104 and one smoke detector (2D101, 2D102, or 2D103).

Select a time for the Releasing Zone Delay Timer (refer to “How to Program a Delay Timer” on page 54.)

To Program	Do this
Cross Zones	Type N, Y, Z, or H in the CROSS= field, or press the NEXT or PREVIOUS keys, <input type="button" value="+"/> or <input type="button" value="-"/> , until N, Y, Z or H appears in the that field.

Press  at this point to save the Cross Zone value if no other fields on the screen are changing. To change another field on the screen, move the cursor into position by pressing the arrow keys on the keypad.

## How to Program a Soak Timer (NFPA 16 Applications Only)

The Soak Timer specifies the length of time (0001 to 9999 seconds, or 0000 for not used) to dump releasing agents when a Releasing Zone activates. When the Soak Timer expires, the control panel automatically shuts off the releasing solenoids for the active Releasing Zone. To program a Soak Timer for a Releasing Zone, follow these instructions:

To Program	Do this
Soak Timer	Type a seconds value of 0000 (no soak timer) to 9999 from the numeric keys on the keypad in the SOK= field.

Press  at this point to save the Soak Timer value if no other fields on the screen are changing. To change another field on the screen, move the cursor into position by pressing the arrow keys on the keypad.

A Soak Timer value of 600 seconds is shown below:

```
PRG RELEASE FUNCTION RELEASE CONTROL
DELAY=00 ABORT=ULI CROSS=N SOK=0600 R00
```



## Using Type Codes for Releasing Zones

The control panel provides a set of Type Codes designed for releasing applications for inputs and outputs. This section details how to program each of these Type Codes.

**Note:** Do not assign Releasing Type Codes to Panel Circuits, with the exception of the audible Type Codes REL END BELL and REL AUDIBLE.

Type Codes designed for Releasing Zone **inputs** (monitor modules).

Type Code	What the Type Code does	Refer to
ABORT SWITCH (tracking)	Provides an abort function through a monitor module (connected to a UL-listed abort station) for a Releasing Zone.	“How to Program an Abort Switch” on page 66
MAN. RELEASE (latching)	Provides a manual release through a monitor module (connected to a UL-listed pull station) for a Releasing Zone.	“How to Program a Manual Release Switch” on page 67
MAN REL DELAY (latching)	Provides a manual release with a 10-second delay through a monitor module (connected to a UL-listed pull station) for a Releasing Zone.	“How to Program a Manual Release Delay Switch” on page 68
SECOND SHOT (latching)	Provides a second manual release through a monitor module (connected to a UL-listed pull station) for a Releasing Zone.	“How to Program a Second Shot Switch” on page 70

Type Codes designed for Releasing Zone **outputs** (control modules and panel NACs, and Panel Circuits with the audible Type Codes REL END BELL and REL AUDIBLE).

Type Code	What the Type Code does	Refer to
REL END BELL	Activates a NAC audio or visual device when releasing circuits shut off.	“How to Program a Release End Bell Circuit” on page 71
REL CKT ULC	Directs outputs to perform a release function as required by ULC.	“How to Program a ULC Release Circuit” on page 72
RELEASE CKT	Directs outputs to perform a releasing function.	“How to Program a Release Circuit for an Output Circuit” on page 73
RELEA. FORM C	Directs relay outputs to perform a releasing function.	“How to Program a Release Form-C Circuit” on page 74
REL AUDIBLE	Activates audio or visual devices steady when releasing starts.	“How to Program a Release Audible Circuit” on page 75
INSTANT RELE	Activates non-releasing output (panel NAC or control modules) with no delay time.	“How to Program an Instant Release Circuit” on page 76
REL CODE BELL	Activates audio or visual devices to pulse at 20 ppm (Delay Timer activation) or 120 ppm (Cross Zone activation).	“How to Program a Release Code Bell Circuit” on page 77

### How to Program an Abort Switch

The following contains information needed to program an Abort Switch for a monitor module.

**Description** A monitor module, connected to a UL-listed abort station (such as the Notifier NBG-12LRA), that you use as an abort switch for a Releasing Zone. You can program multiple monitor modules with the ABORT SWITCH Type Code that work like multiple conventional abort switches on a conventional zone.

- How to program**
1. Select a monitor module that you want to use as an Abort Switch (refer to “How to Modify or Delete a Point (2 =POINTS)” on page 21).
  2. Select the ABORT SWITCH Type Code.



3. Select the Releasing Zone (R0-R9) for your releasing application.
4. Press the ENTER key to save, then press the ESC key until you return to the Program Change screen.
5. Select the type of Abort Switch for your releasing application (refer to “How to Program an Abort Switch” on page 54).

**Example** A programming example of a monitor module programmed as an Abort Switch for Releasing Zone R5.

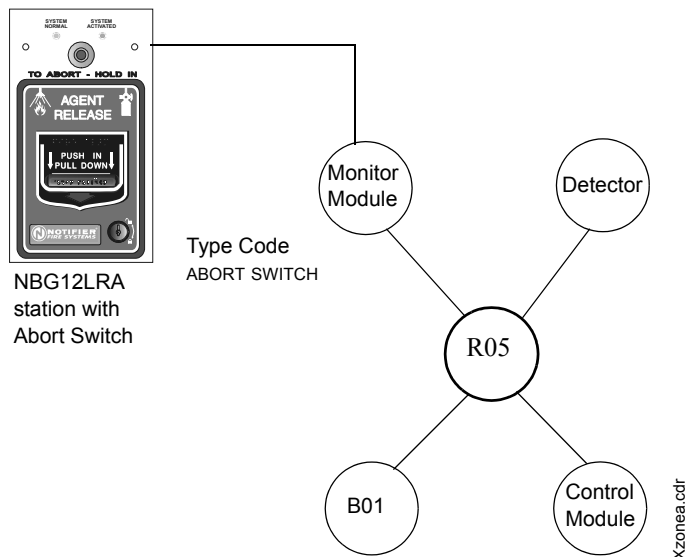

**Figure 12 Monitor Module Configured as an Abort Switch**

### How to Program a Manual Release Switch

The following contains information needed to program a Manual Release switch for a monitor module.

**Description** A monitor module—connected to a UL-listed manual station (such as the Notifier NBG-12LRA)—used to manually release agents. A Manual Release switch overrides all timers, such as a Delay Timer or a Soak Timer. You can install multiple monitor modules with a MAN. RELEASE Type Code that work like multiple conventional manual release switches on a conventional zone.

- How to program**
1. Select a monitor module (refer to “How to Modify or Delete a Point (2=point)” on page 21) that you want to use for the manual release function.
  2. Select the MAN. RELEASE Type Code.

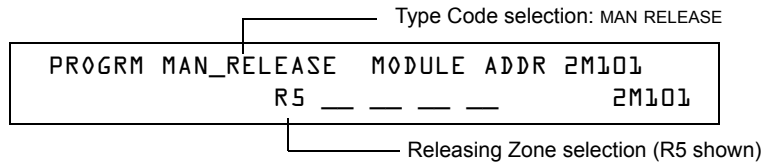

3. Select the Releasing Zone (R0-R9) for your releasing application.
4. Press the ENTER key to save, then press the ESC key until you return to the Program Change screen.

**Example** A programming example of a monitor module programmed as a manual release switch for Releasing Zone R5.

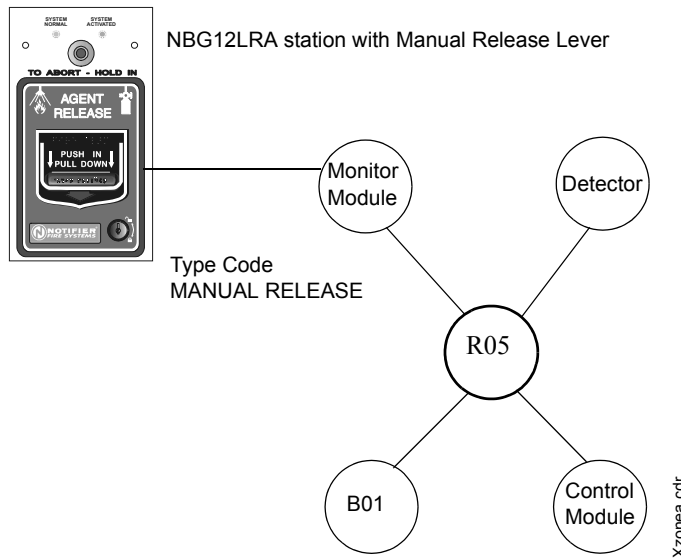

**Figure 13 Monitor Module Configured as a Manual Release Switch**

## How to Program a Manual Release Delay Switch

The following contains information needed to program a Manual Release Delay switch for a monitor module

**Description** A monitor module—connected to a UL-listed manual station (such as the Notifier NBG-12LRA)—used to initiate a manual release with 30-second delay time.

A Manual Release Delay switch overrides the FACP programmed Delay Timer in certain circumstances, but not the soak timer.

Multiple monitor modules can be programmed with a MANREL DELAY Type Code. They work like multiple conventional manual release switches on a conventional zone.

### How to program

1. Select a monitor module (refer to “How to Modify or Delete a Point (2=POINT)” on page 20) that you want to use for the manual release function.
2. Select the MANREL DELAY Type Code.

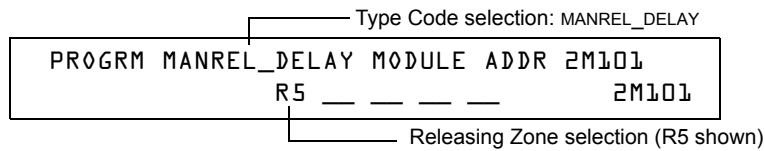

3. Select the Releasing Zone (R0-R9) for your releasing application.
4. Press the ENTER key to save, then press the ESC key until you return to the Program Change screen.

**Example:** A programming example of a Monitor Module module programmed for MANREL DELAY switch for Releasing Zone R5.

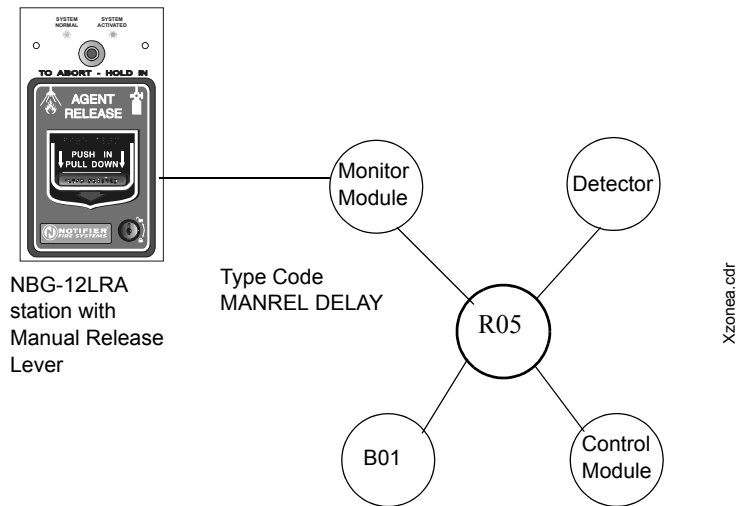

**Figure 14 Monitor Module Configured as a Manual Release Delay Switch**

For Example, program Releasing Zone R5 with a Manual Release Delay switch for the following releasing selections:

```
PRG RELEASE FUNCTION RELEASE CONTROL
DELAY=60 ABORT=ULI CROSS=N SOK=0030 R05
```

When the Manual Release Delay Switch activates, the control panel replaces the Delay Time with 30 seconds if the Delay Timer has not counted down below 30 seconds. If the Delay Timer has counted down to 30 seconds or less, no change is

made to the countdown.

Examples:

1. The FACP programmed Delay Timer begins its 60 second countdown. The Manual Release Delay switch is pulled when the FACP Delay Timer has counted down to 48 seconds. The 48 seconds remaining in the countdown are overridden by the 30-second delay initiated by the Manual Delay switch. In this example, the total time elapsing from FACP countdown initiation to agent release is 42 seconds (12 + 30), less than the original 60 second FACP Delay Timer countdown.
2. The FACP programmed Delay Time begins its 60 second countdown. The Manual Release Delay switch is pulled when the FACP Delay Timer has counted down to 8 seconds. The 8 seconds remaining in the countdown is not changed. In this example, the total time elapsing from FACP countdown initiation to agent release is 60 seconds.
3. The FACP programmed Delay Time is not running (as would happen if the releasing station were pulled before an alarm registered). The Manual Release Delay Switch is activated by the pull station. Agent release will occur in 30 seconds.

### How to Program a Second Shot Switch

**Note:** The Second Shot switch can only be used with the MANREL DELAY Type Code.

The following contains information needed to program a Second Shot switch for a monitor module.

- Description** A monitor module—connected to a UL-listed manual station (such as the NBG-12LRA)—used as for a second release of agents. A Second Shot switch overrides a Delay Timer, programmed to the same Releasing Zone.
- How to program**
1. Select a monitor module (refer to “How to Modify or Delete a Point (2=point)” on page 21) that you want to use for the manual release function.
  2. Select the SECOND SHOT Type Code.

```

Type Code selection: SECOND_SHOT
PROGRAM SECOND_SHOT MODULE ADDR 2M101
R5 _____ 2M101
Releasing Zone selection (R5 shown)
    
```

3. Select the Releasing Zone (R0-R9) for your releasing application.
4. Press the ENTER key to save, then press the ESC key until you return to the Program Change screen.

**Example** A programming example of a monitor module programmed as a MANREL DELAY switch for the first shot and a Second Shot switch for the second shot.

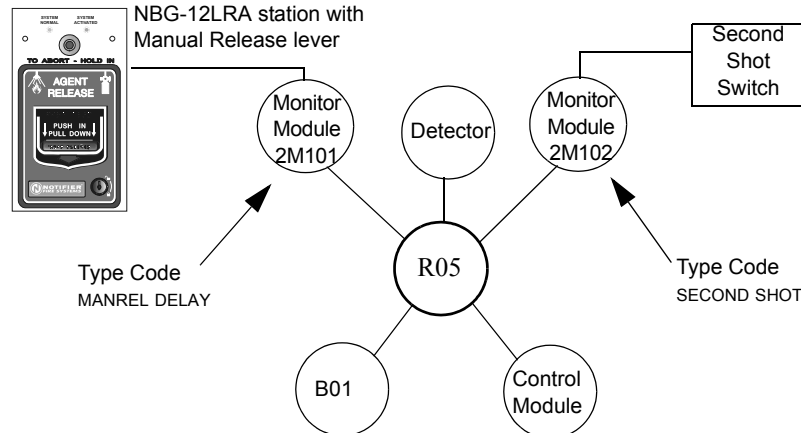

**Figure 15 Monitor Module Configured as a Second Shot Switch**

With two monitor modules configured as shown above, program Releasing Zone R5 with the following releasing selections.

```

PRG RELEASE FUNCTION RELEASE CONTROL
DELAY=15 ABORT=ULI CROSS=Y SOAK=0030 R05
    
```

R05 can be activated in one of two ways, as described in the examples given below.

**Example 1:** If the detector initiates the alarm, R05 activates. Releasing begins after the delay timer has expired (15 seconds). Releasing will continue for the soak timer duration (30 seconds). The Second Shot switch can then be activated, and will remain activated for as long as the switch is held on. Second Shot releasing will end when the switch is no longer held on (behaving like a tracking function).

**Example 2:** If the NBG-12LRA (Type Code MANREL DELAY) lever is pulled, the delay timer begins its 15 second countdown. Releasing will begin after the delay timer has expired, and will continue for the soak timer duration (30 seconds). The Second Shot switch can then be activated, and will remain activated for as long as the switch is held on. Second Shot releasing will end when the switch is no longer held on (behaving like a tracking function).

### How to Program a Release End Bell Circuit

**Note:** A releasing circuit with this Type Code requires the following selections: A Releasing Zone selection (R0-R9); An output circuit mapped to the same Releasing Zone; Switch Inhibit selected; Non-Silenceable; No Walk Test.

The following contains information needed to program a Release End Bell circuit for a control module a NAC or a Panel Circuit.

**Description** A control module, NAC, or Panel Circuit to activate an audible or visual device when releasing devices shut off. You can also program multiple outputs with the REL END BELL Type Code to the same Releasing Zone. When all the Releasing Zone functions are complete, all outputs with the REL END BELL Type Code activate at the same time. A REL END BELL circuit remains on until you reset the system.

- How to program**
1. Select a control module, NAC or Panel Circuit (refer to “How To Modify Or Delete A Point (2=POINT)” on page 21) that you want to use as a Release End Bell circuit.
  2. Select the REL END BELL Type Code, as shown in the following example (control module shown).

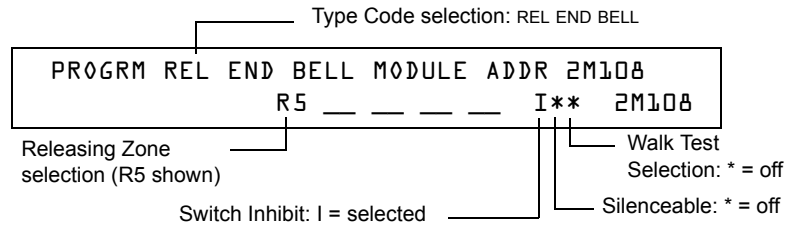

3. Select the Releasing Zone (R0-R9) for your releasing application.
4. Press the ENTER key to save, then press the ESC key two times to return to the Program Change screen.

**Example**

A programming example of a control module programmed as a Release End Bell for Releasing Zone R5.

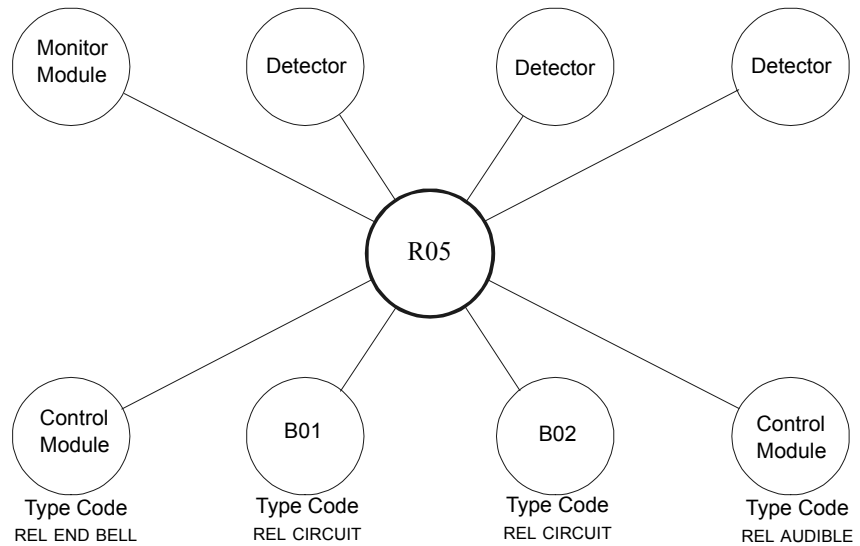

For example, a control module programmed with the REL END BELL Type Code activates when all releasing functions, such as the releasing functions programmed for R05 shut off.

Xzone4.cdr

**Figure 16 Control Module Configured as a Release End Bell Circuit**

### How to Program a ULC Release Circuit

**Note:** A ULC Release Circuit with this Type Code requires the following selections: A Releasing Zone selection (R0-R9); An output circuit mapped to the same Releasing Zone; Switch Inhibit selected; Non-Silenceable; No Walk Test.

The following contains information needed to program a ULC Release Circuit for a control module or a NAC.

**Description** A control module or a NAC used to activate a releasing solenoid or other releasing device. You can also program multiple outputs with the REL CKT ULC Type Code to the same Releasing Zone. When the Releasing Zone activates, all outputs with the REL CKT ULC Type Code also activate at the same time. A ULC Release Circuit activates when:

- An initiating device programmed to the same Releasing Zone activates (two devices if using the Cross Zone option)
- The Delay Timer for R0-R9 (if used) expires
- No Abort Switch for R0-R9 (if used) is active

A ULC Release Circuit—and all wiring to the release device—is fully supervised and usable with power-limited energy cable.

**How to program**

1. Select a control module or a NAC (refer to “How To Modify Or Delete A Point (2=POINT)” on page 21) that you want to use as a ULC Release Circuit.
2. Select the REL CKT ULC Type Code, as shown in the following example (control module shown).

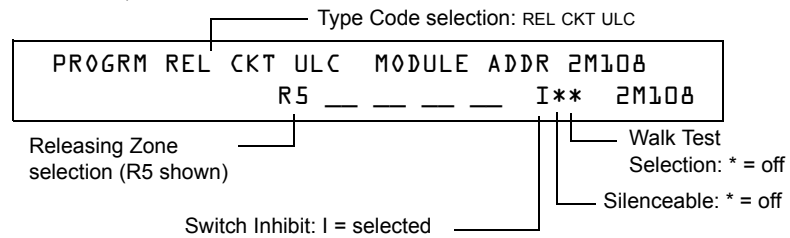

3. Select the Releasing Zone (R0-R9) for your releasing application.
4. Press the ENTER key to save, then press the ESC key two times to return to the Program Change screen.

**Example**

A programming example of a control module programmed as a ULC Release Circuit for Releasing Zone R5.

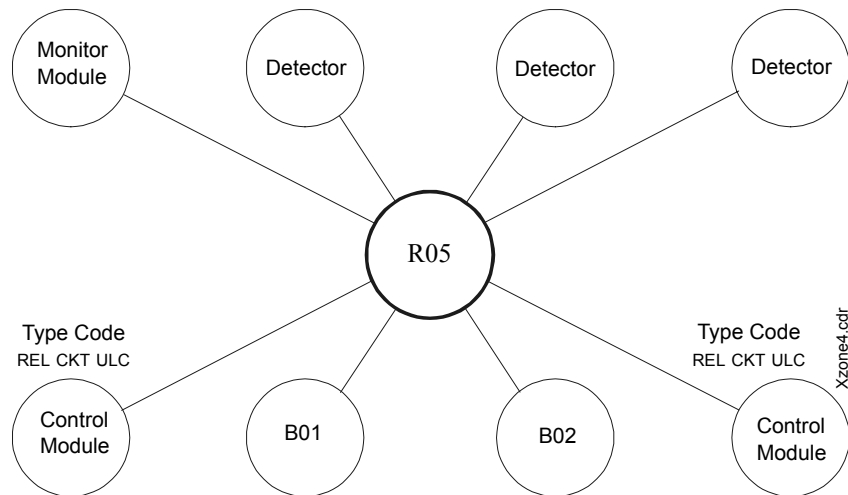

For example, all control modules programmed with the REL CKT ULC Type Code activate simultaneously with other outputs programmed for R5 (B01, B02).

**Figure 17 Control Module Configured as a ULC Release Circuit**



### How to Program a Release Circuit for an Output Circuit

**Note:** A Release Circuit with this Type Code requires the following selections: A Releasing Zone selection (R0-R9); An output circuit mapped to the same Releasing Zone; Switch Inhibit selected; Non-Silenceable; No Walk Test.

**Note:** Do not use a Release Circuit for the following: An application requiring ULC Listing; An application requiring power-limited energy cable.

The following contains information needed to program a Release Circuit for an output circuit (control module or NAC).

**Description** A control module or a NAC used to activate a releasing solenoid or other releasing device. You can also program multiple outputs with the RELEASE CKT Type Code to the same Releasing Zone. When the Releasing Zone activates, all outputs associated with the releasing zone and with the RELEASE CKT Type Code also activate at the same time. A Release Circuit activates when:

- An initiating device programmed to the same Releasing Zone activates (two devices if using the Cross Zone option)
- The Delay Timer for R0-R9 (if used) expires
- The Abort Switch for R0-R9 (if used) is not active

**How to program**

1. Select a control module or a NAC (refer to “How to Modify or Delete a Point (2=POINT)” on page 21) that you want to use as a Release Circuit.
2. Select the RELEASE CKT Type Code, as shown in the following example (control module shown).

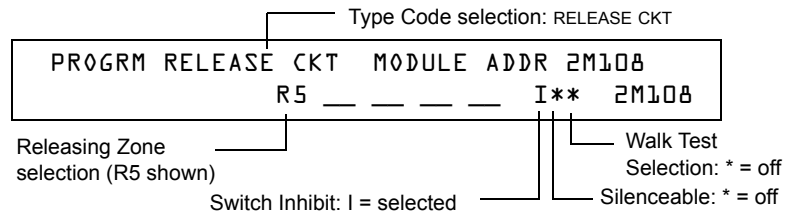

3. Select the Releasing Zone (R0-R9) for your releasing application.
4. Press the ENTER key to save, then press the ESC key two times to return to the Program Change screen.

**Example**

A programming example of a control module programmed as a Release Circuit for Releasing Zone R5.

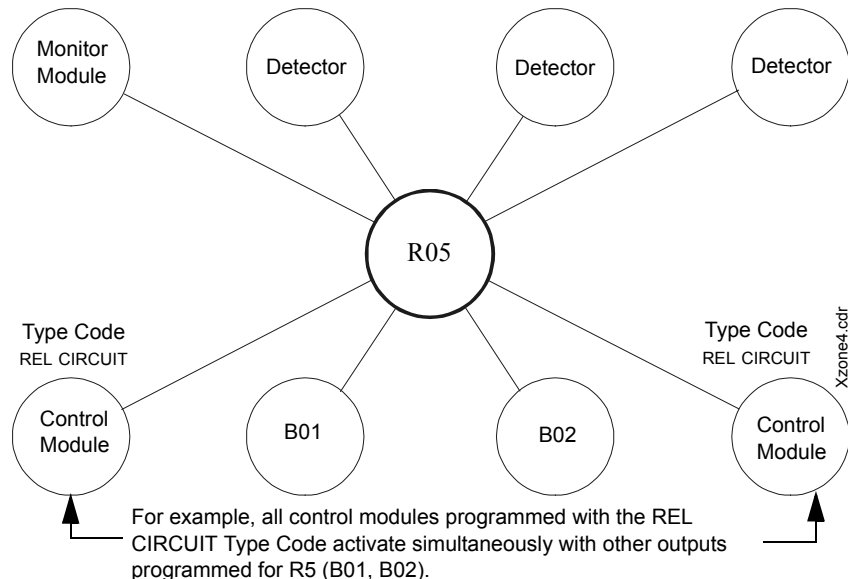

**Figure 18 Control Module Configured as a Release Circuit**

### How to Program a Release Form-C Circuit

**Note:** An output with a RELEA.FORM C Type Code requires the following selections: A Releasing Zone selection (R0-R9); An output circuit mapped to the same Releasing Zone; Switch Inhibit selected; Non-Silenceable; No Walk Test.

The following contains information needed to program a Release Form-C circuit for an output circuit.

**Description** An output circuit, configured as a relay, programmed to activate an output by opening or closing a switch. Typical applications include closing doors and air handlers.

- How to program**
1. Select a control module (refer to “How To Modify Or Delete A Point (2=POINT)” on page 21) that you want to use as a Releasing Form-C Circuit.
  2. Select the RELEA.FORM C Type Code, as shown in the following example (control module shown).

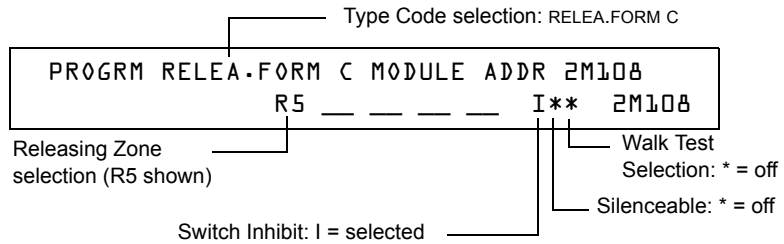

3. Select the Releasing Zone (R0-R9) for your releasing application.
4. Press the ENTER key to save, then press the ESC key two times to return to the Program Change screen.

**Example** A programming example of a control module programmed as a Release Form-C circuit for Releasing Zone R5.

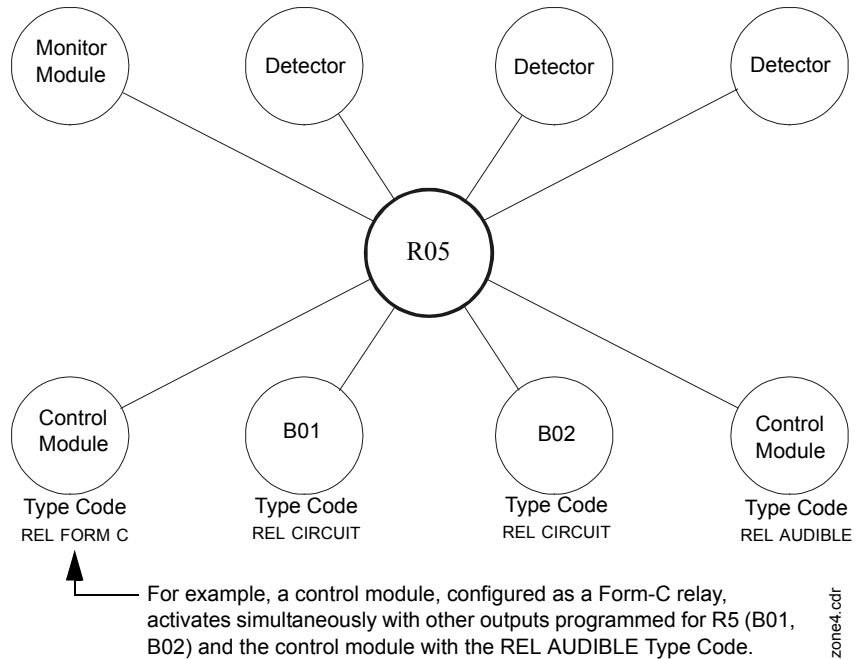

**Figure 19 Control Module Configured as a Release Form-C Circuit**

Xzone4.cdr

### How to Program a Release Audible Circuit

**Note:** An output with a REL AUDIBLE Type Code requires the following selections: A Releasing Zone selection (R0-R9); An output circuit mapped to the same Releasing Zone; Switch Inhibit selected; Non-Silenceable; No Walk Test.

The following contains information needed to program a Release Audible circuit for an output circuit (control module, NAC, or Panel Circuit).

**Description** An output circuit programmed to activate an audio or visual device when all releasing outputs, programmed to the same Releasing Zone, turn on. You can also program multiple outputs with the REL AUDIBLE Type Code to the same Releasing Zone. When the Releasing Zone activates, all outputs with the REL AUDIBLE Type Code activate at the same time.

- How to program**
1. Select a control module, NAC, or Panel Circuit (refer to “How To Modify Or Delete A Point (2=POINT)” on page 21) that you want to use as a Releasing Circuit.
  2. Select the REL AUDIBLE Type Code, as shown in the following example (control module shown).

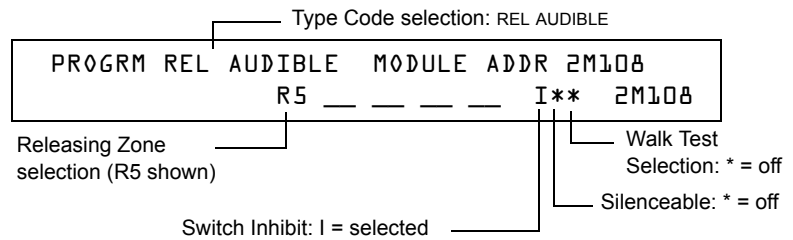

3. Select the Releasing Zone (R0-R9) for your releasing application.
4. Press the ENTER key to save, then press the ESC key two times to return to the Program Change screen.

**Example** A programming example of a control module programmed as a Release Audible circuit for Releasing Zone R5.

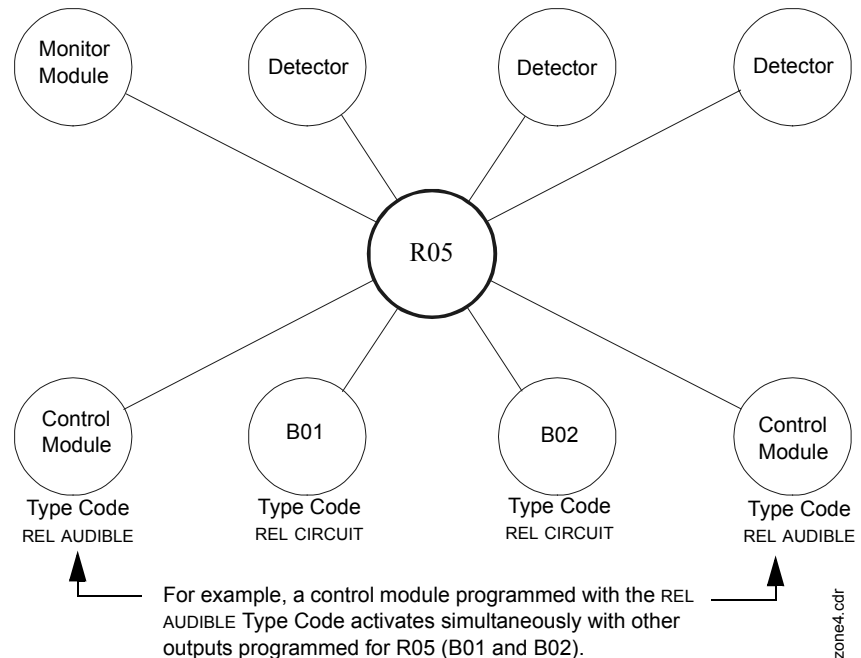

**Figure 20 Control Module Configured as a Release Audible Circuit**

**How to Program an Instant Release Circuit**

**Note:** An output with an INSTANT RELE Type Code requires the following selections: a zone selection (a releasing zone may be used, but is not required); an output circuit mapped to the same zone; Switch Inhibit selected; Non-Silenceable; No Walk Test.

The following contains information needed to program an Instant Release circuit for an output circuit (control module or NAC).

**Description** An output circuit programmed to activate non-releasing devices, such as door openers or warning sounders, without counting down delay timers. A device programmed with the INSTANT RELE Type Code device is supervised for open circuits and ground faults.

- How to program**
1. Select a control module or a NAC (refer to “How To Modify Or Delete A Point (2=POINT)” on page 21) that you want to use as a Releasing Circuit.
  2. Select the INSTANT RELE Type Code, as shown in the following example (control module shown).

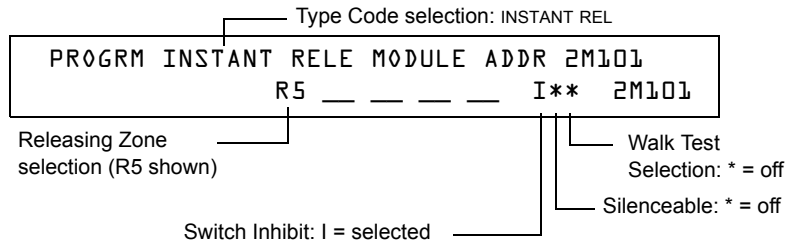

3. Select the Releasing Zone (R0-R9) for your releasing application.
4. Press the ENTER key to save, then press the ESC key two times to return to the Program Change screen.

**Example** A programming example of a control module programmed as an Instant Release circuit for Releasing Zone R5.

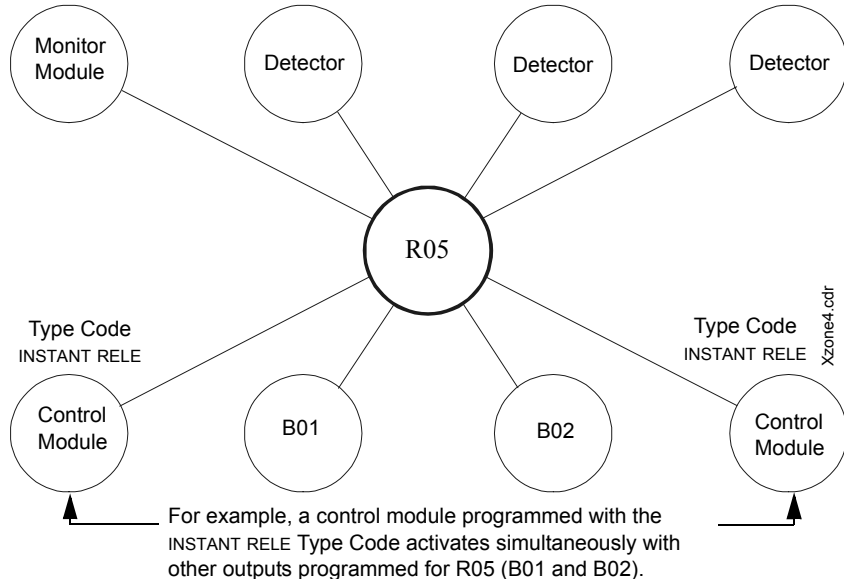

**Figure 21 Control Module Configured as an Instant Release Circuit**

### How to Program a Release Code Bell Circuit

**Note:** An output with a REL CODE BELL Type Code requires the following selections: A Releasing Zone selection (R0-R9); An input circuit mapped to the same Releasing Zone.

**Note:** For instructions on programming Switch Inhibit, Silenceable, and Walk Test, refer to “How to Modify NAC and Panel Circuit Points” on page 25.

The following contains information needed to program a Release Code Bell circuit for a NAC.

**Description**

A NAC programmed to pulse an audio or visual device as follows:

- 20 ppm when a Delay Timer activates
- 120 ppm when a Cross Zone activates

**How to program**

1. Select a NAC (refer to “How To Program NAC And Panel Circuit Points” on page 25) that you want to use as a Release Code Bell Circuit.
2. Select the REL CODE BELL Type Code, as shown in the following example (NAC shown).

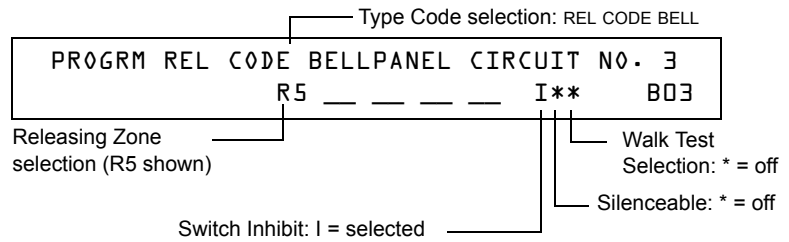

3. Select the Releasing Zone (R0-R9) for your releasing application.
4. Press the ENTER key to save, then press the ESC key two times to return to the Program Change screen.

**Example**

A programming example of a NAC programmed as a Release Code Bell circuit for Releasing Zone R5.

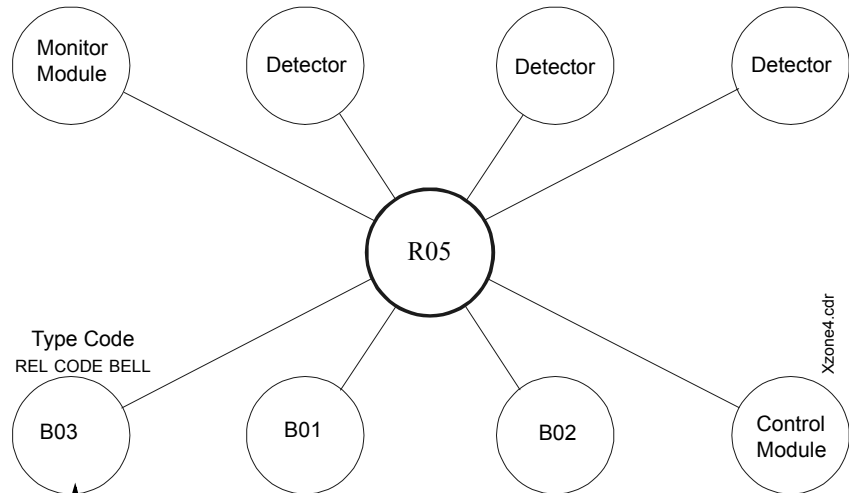

A NAC programmed with the REL CODE BELL Type Code activates simultaneously with other outputs programmed for R05 (B01 and B02).

**Figure 22 NAC Configured as a Release Code Bell Circuit**

## Initiating Devices

Releasing zone initiating devices include the following:

- FST-751 intelligent heat detectors
- FSI-751, FSP-751, FAPT-751, FSL-751 intelligent smoke detectors
- Conventional detection UL-listed devices connected to monitor modules

Refer to the SLC manual for the most up-to-date information about initiating devices.

You can use multiple zone initiating devices for the same releasing hazard. Do so by mapping zone initiating devices to the same Releasing Zone. Factory Mutual and certain Local Authorities Having Jurisdiction require using redundant wiring (NFPA 72-1999 Style 6 or Style D) for initiating devices in releasing applications.

## Warning Sounders

Warning sounders connect to any of the four panel NACs, to Panel Circuits, or to control module circuits (refer to the *NFS-640 Installation Manual*). Note the following:

- If selecting Cross Zones, a warning sounder only activates when two zones alarm.
- Warning sounders—unlike release solenoids—do not wait for a Delay Timer.
- If Coding Functions are required for warning sounders, use one of the NACs—not a control module.
- The same releasing hazard can activate multiple NACs.

Instructions for activating warning sounders:

To activate a sounder	Do this
When the Delay Timer starts, when the releasing device activates, or both	Map the control module, Panel Circuit or NAC to a releasing hazard zone (R0-R9).
Immediately when one of the initiating devices activate	Map the control or NAC, or Panel Circuit to a separate zone (not R0-R9) that is also mapped to all initiating devices of the hazard.

## Auxiliary Control Functions

Instructions for using control functions:

Function	Do this
A releasing application requires control relays	Use control modules set for dry contact operation. Program the control relays for different functions by following the instructions in “To activate a sounder” above.
Providing control functions	Use an ACM-8R remote relay module mapped to the software zones of the control panel.

## ACS Annunciation

Instructions for annunciating ACS points and detectors:

To Annunciate	Do this
Points of releasing functions	Select ACS Selection Group B to annunciate any of the software zones described previously, including zones R0-R9. For instructions, refer to “Annunciator Options” on page 33.
Individual detectors	Select ACS Selection Group H, I, J, K or L. For instructions, refer to “Annunciator Options” on page 33.

## Notes

# Appendix B: Special Zone Outputs

## Presignal and Positive Alarm Sequence (PAS)

### What is Presignal and PAS?

#### Purpose

Presignal is a feature that initially causes alarm signals to only sound in specific areas, monitored by qualified persons. This allows delay of the alarm up to 180 seconds after the start of alarm processing. The control panel Presignal feature provides two selections:

- A **Presignal Delay Timer** (60-180 seconds) that delays activation of all outputs with a CBE that includes Special Zone F0.
- A **PAS** (Positive Alarm Sequence) selection, in addition to the **Presignal Delay Timer**, that allows a 15-second time period for acknowledging an alarm signal from a fire detection/initiating device. If the alarm is not acknowledged within 15 seconds, all local and remote outputs activate immediately and automatically.

An illustration of Presignal and PAS timing.

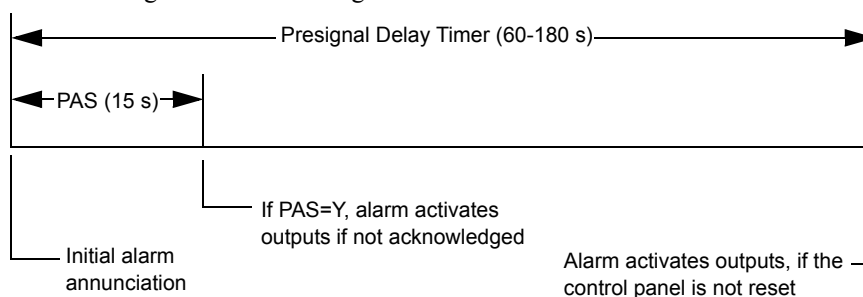

**Figure 23 Presignal and PAS Time**

The control panel delays activation of outputs containing F0 in their Control-By-Event (CBE) list for all alarm initiating devices that contain F0 in their CBE list. A subsequent alarm will abort the Presignal Delay Timer and execute CBE lists.

#### Notes on using F0

- NFPA 72-1999 requires installation of a PAS Inhibit switch, that you can use to turn off the PAS delay timer when the control panel is unattended. Do so by programming a monitor module with the Type Code, PAS INHIBIT. For details, refer to “How to Modify an Addressable Monitor Module Point” on page 23.
- Abort circuit activates by pressing the SIGNAL SILENCE key before the Presignal Delay Timer expires.
- Program zone F0 to participating inputs and outputs that have appropriate CBE zone map entries.

#### Restrictions on using F0

- Do not include F0 in the CBE list for a releasing device.
- Do not include F0 in the CBE list for any monitor module that connects to a device other than an automatic fire detector.



## Selecting Presignal and PAS Outputs

### Presignal

You can set Presignal Delay Timer between 60 and 180 seconds. A Presignal Delay Timer does not apply to the following:

- The System Alarm relay
- TM-4 polarity reversal alarm output
- TM-4 municipal box output
- UDACT

### Positive Alarm Sequence (PAS)

Outputs selected for PAS delay for 15 seconds. Pressing the ACKNOWLEDGE/SCROLL DISPLAY key within the 15-second delay will set the Presignal Delay Timer to the full programmed value (60-180 seconds, including the PAS delay of 15 seconds). When an alarm comes from an initiating device with a CBE list that includes F0, the control panel delays the following outputs:

- System Alarm relay
- TM-4 Polarity Reversal Alarm output
- TM-4 Municipal Box output
- UDACT

## Time Control Zones

**Note:** All active Time Control outputs will turn off temporarily while resetting or programming the control panel.

All outputs with a CBE list containing F5 or F6 activate within the times specified for the days of the week listed in F5 or F6. All smoke detectors with a CBE list containing F5 or F6 switch to their occupied level (lowest sensitivity, AL:9) within the times specified for the days of the week listed in ZF5 or ZF6. Refer to “Appendix C: AWACS™ Applications” on page 84 for details on setting detector sensitivity.

Time Control is active for all days of the week listed in F5 or F6. Holidays listed in F7 are excluded unless you list Holidays (H) in the day-of-week selection of F5 and F6. Enter the time in a 24-hour format with the OFF time later than the ON time. After changing programming using Time Control, always reset the control panel.

## Coding Functions for NACS and Panel Circuits

Coding Functions are pulsed signals that you can select, using Special Zone F8, to energize NACs and Panel Circuits when a fire alarm activates. NACs and Panel Circuits with a CBE list that includes F8.

**Note:** Do not include F8 in the CBE list of NACs and Panel Circuits used for releasing or zone coding applications.

Select Coding Functions on a global basis, through Special Zone F8. That is, all NACs and Panel Circuits selected for Coding Functions, will sound the same code when activated. The table below contains descriptions of each Coding Function selection:

Coding Function Selection	Signal
March Time (default)	120 PPM (pulses per minute)
Temporal	0.5s on, 0.5s off, 0.5s on, 0.5s off, 0.5s on, 1.5s off, repeats
California	10 sec. on, 5 sec. off, repeats
Two-stage	Alert signal - 20 PPM; General Alarm Signal - Temporal
Two-Stage Canada 3	Alert Signal - 20 PPM; Drill Switch activated - Temporal (3 min. timeout)
Two-Stage Canada 5	Alert Signal - 20 PPM; Drill Switch activated - Temporal (5 min. timeout)
System Sensor Strobe	Synchronizes System Sensor Horn/Strobes (Applies to NAC on CPU-640 only)

**Table 28 Coding Function Selections**

Before selecting an output for Two-stage coding, note the following:

The control panel automatically sends an Alert Signal to any of the four NACs mapped to Z00 and F8, but not mapped to the alarm signal. After five minutes without an acknowledge or silence, the Alert Signal changes to Temporal pattern.

Two-stage Canada 3 and 5: Function the same as Two-stage except the second stage is achieved when

- The three or five minute timer expires without an acknowledge or silence.
- OR
- The Drill Switch (or an input programmed with the type code DRILL\_SWITCH or EVACUATE\_SW) is activated.

If Acknowledge or Silence is pressed within the three or five minute timeout period, the NAC will remain at first stage. Subsequent alarm(s) will restart the timer.

## Notes

# Appendix C: AWACS™ Applications

## AWACS Overview

AWACS™ (Advanced Warning Addressable Combustion Sensing) is a set of software algorithms that provide the NFS-640 with industry-leading smoke detection capability. You can program AWACS functions on a global or on a per-detector basis.

AWACS topics covered in this appendix:

Topic	Page
<b>AWACS features</b> – Descriptions of AWACS features, such as Drift Compensation, Sensitivity Adjust, programmable on a per-detector basis.	84
<b>Pre-Alarm</b> – Alert and Action settings, programming (global settings).	89
<b>Detector Sensitivity Settings</b> – Pre-Alarm and Alarm sensitivity settings for photo, ion, laser, and multisensor detectors programmable on a per-detector basis.	90
<b>Detector Maintenance Features</b> – Instructions for viewing and printing detector maintenance information.	92

## AWACS Features

AWACS features include the following:

- Drift Compensation and Smoothing
- Maintenance Warnings - Three Levels
- Self-optimizing Pre-Alarm
- Detector Sensitivity
- Cooperative Multi-Detector Sensing

### Drift Compensation and Smoothing

Drift compensation uses algorithms (U.S. patent pending) that identify and compensate for long-term changes in the analog readings from each smoke detector. (Typically, dirt and dust accumulation inside the smoke chamber causes long-term changes in detector readings.) Drift compensation does the following:

- Allows a detector to retain its original ability to detect actual smoke, and resist false alarms, even as dirt and dust accumulates.
- Reduces maintenance requirements by allowing the control panel to automatically perform the periodic sensitivity measurements required by NFPA Standard 72-1999.

The software also provides smoothing filters to remove transient noise signals, usually caused by electrical interference. Different smoothing algorithms are used, depending on the sensitivity selection of each detector. Refer to “Detector Sensitivity Settings” on page 90 for more information on detector sensitivity levels.

*Continued on the next page...*

A graphic representation of a detector analog reading using drift compensation and smoothing:

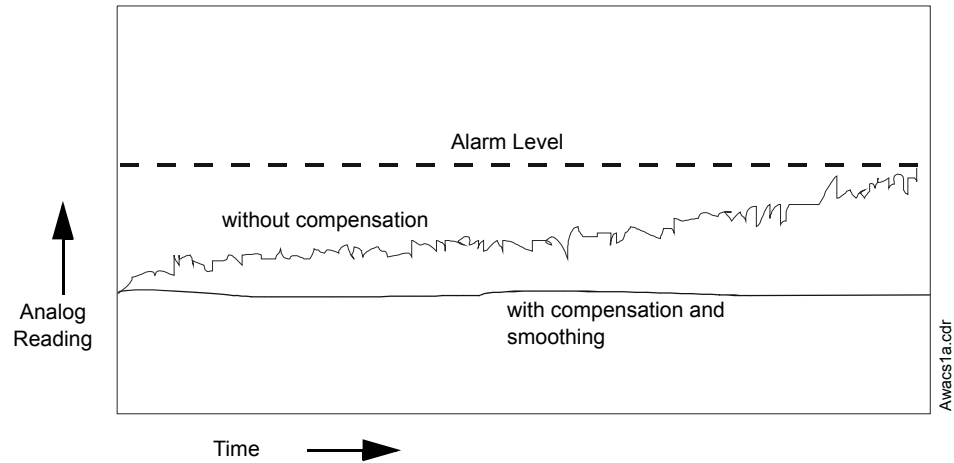

**Figure 24 Graphic Representation of Drift Compensation**

### Maintenance Warnings – Three Levels

The software determines when the drift compensation for a detector reaches an unacceptable level that can compromise detector performance. When a detector reaches an unacceptable level, the control panel indicates a maintenance warning. The table below summarizes the three levels of AWACS maintenance warnings:

Maintenance Level	Indicates
Low Chamber value	A hardware problem in the detector.
Maintenance Alert	Dust accumulation that is near but below the allowed limit. The Maintenance Alert level indicates the need for maintenance before the performance of the detector is compromised.
Maintenance Urgent	Dust accumulation above the allowed limit.

**Table 29 Definitions of AWACS Maintenance Levels**

A graphic representation of the maintenance levels:

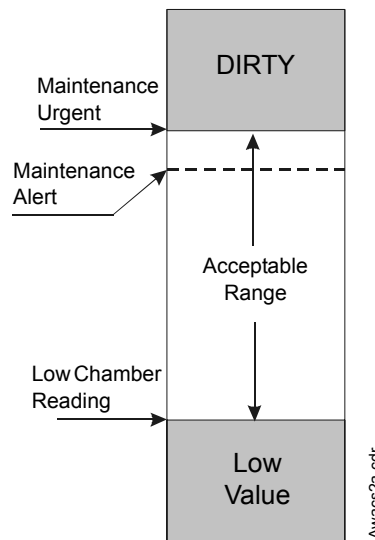

**Figure 25 Diagram of Maintenance Levels**

### Self-Optimizing Pre-Alarm

You can set each detector, except FST-751 (Heat), for Self-Optimizing Pre-Alarm (PA=1). In this Self-Optimizing mode, the software measures the normal peak analog readings and sets the Pre-Alarm level just above these normal peaks. This allows extremely sensitive Pre-Alarm capability with reasonable protection against non-fire signals. The figure below shows a graphical representation of the Self-Optimizing Pre-Alarm level:

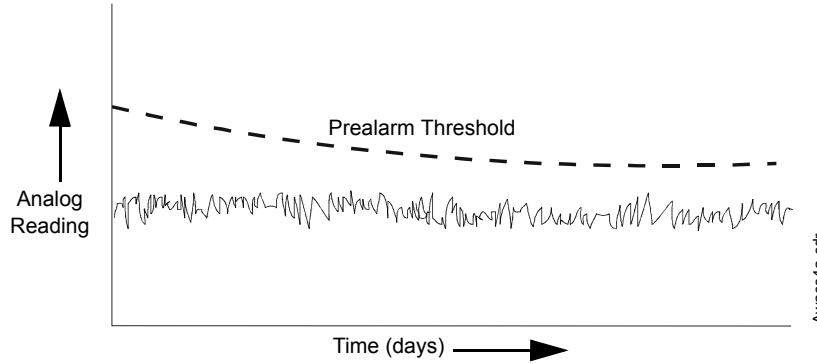

**Figure 26 Self-optimizing Pre-Alarm Level**

For more information on setting Pre-Alarm levels, refer to the following sections:

- “How to Change Sensitivity for a Detector” on page 48
- “How to Use the Detector Sensitivity Screen” on page 48

### Detector Sensitivity

The control panel provides nine Sensitivity Levels for alarm detection and pre-alarm as follows:

**Note:** For a list of all detector sensitivity levels, see Table 30 on page 90.

- **Alarm Sensitivity Levels** You can select the sensitivity of a detector from 1-9 (1=highest sensitivity; 9=lowest sensitivity).
- **Pre-Alarm Sensitivity Levels** You can select one of nine levels from 1 to 9 (0=no Pre-Alarm, 1=self-optimizing, 2=highest sensitivity, 9=lowest sensitivity). You can set Pre-Alarm operation to Action (latching) or Alert (non-latching) and to activate Special Zones. For instructions on programming, refer to “How to Select a Pre-Alarm Level” on page 89.

You can set the sensitivity levels as fixed or programmed for day and night operation. For details, refer to “Time Control Zones” on page 82.

A sample sensitivity window for a laser detector:

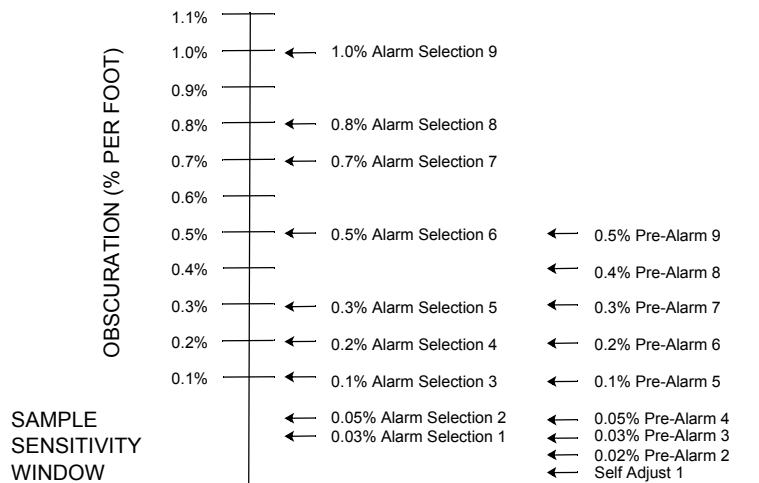

**Figure 27 Sensitivity Levels for a Laser Detector**

### Cooperative Multi-Detector Sensing

Cooperative Multi-Detector Sensing is the ability of a smoke detector to consider readings from nearby detectors in making alarm or pre-alarm decisions. Each detector can include up to two other detectors in its decision. Without statistical sacrifice in the ability to resist false alarms, Cooperative Multi-Detector Sensing allows a detector to increase its sensitivity to actual smoke by a factor of almost 2 to 1. Cooperative Multi-Detector Sensing also allows the combination of ionization with photoelectric technology in reaching an alarm decision. The figure below shows a graph representing Cooperative Multi-Detector Sensing:

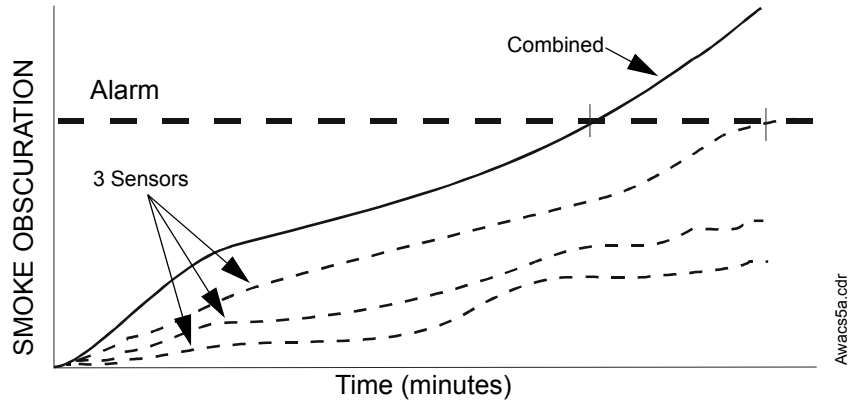

Figure 28 Cooperative Multi-Detector Sensing





the same as in Figure 29 above. The control panel does the following functions when a detector reaches the programmed pre-alarm level:

- The Action message is sent to the History buffer and to any installed terminal mode LCD-80s and printers. The message is sent (and time stamped) only at the time that it first occurred. This historical data could provide valuable information about the progress of a fire.
- The PRE-ALARM LED and panel sounder pulse until acknowledged.
- Zone F09 is activated—but Zone Z00 (general alarm or any other zone) and the System Trouble and System Alarm relays do not activate.
- The fifth zone programmed (not the first four) for this detector activates. The fifth zone is the right-most entry on line two of the detector CBE list in the Point Programming screen. (For more information, refer to “How to Modify an Addressable Detector Point” on page 22). You can use the fifth zone to control functions of a detector or group of detectors once the pre-alarm level is reached. Fifth zone activations also allow ACS annunciation by a detector or group of detectors in Action Pre-Alarm condition.
- The Pre-Alarm condition and the zone programmed will latch until system reset, even if the sensitivity drops below the pre-alarm level.
- A subsequent alarm condition for this detector clears the Action indication from the LCD display alarm list.

## How to Select a Pre-Alarm Level

Instructions and sample displays to program Pre-Alarm for Alert or Action

1. At the “Enter Password” screen, enter your Program Change Password to display the “Program Change Selection” screen. Press **1** to enter the “Basic Program” screen:

```

0=CLR 1=AUTO 2=POINT 3=PASSWD 4=MESSAGE
5=ZONES 6=SPL FUNCT 7=SYSTEM 8=CHECK PRG
6=SPL FUNCT

```

2. From the “Basic Program” screen, press the **6** key to display the “Special Function Zone Change” screen.

```

SPECIAL FUNCTION: F0=PRESIG R0-R9=REL
F5-F6=TIME F7=H0L F8=CODE F9=PRE-ALARM
F9=PRE-ALARM

```

3. From the “Special Function Zone Change” screen, press **F9** to display the “Pre-Alarm Function” screen, with Alert blinking.

```

ALERT blinking
PRG PRELARM FUNCT          ALERT
                             F09

```

4. To select Action, press the **+** (Next Selection) or **-** (Previous Selection) key.

```

ACTION blinking
PRG PRELARM FUNCT          ACTION
                             F09

```

## Detector Sensitivity Settings

### How to Select Pre-Alarm and Alarm Sensitivity

Each detector provides a host of selectable intelligent options. The control panel provides nine levels of Pre-Alarm (PA:1–PA:9) and Alarm (AL:1–AL:9) in percent per foot obscuration:

- **PA:0** no Pre-Alarm selection.
- **PA:1** the self-optimizing setting where the control panel selects a suitable Pre-Alarm level for a detector.
- **PA:2–PA:9** the detector Pre-Alarm sensitivity level - with PA:2 the most sensitive and PA:9 the least sensitive.
- **AL:1–AL:9** the detector Alarm sensitivity level - with AL:1 the most sensitive and AL:9 the least sensitive.

**Note:** \* Signifies the factory default setting.

Detector Type	Alarm (FlashScan)	Alarm (CLIP)	Pre-Alarm
Photo Electric SMOKE (PHOTO)  (See note <sup>1</sup> )	AL:1=0.50 %	AL:1=0.50 %	PA:1=Auto
	AL:2=0.73 %	AL:2=0.73 %	PA:2=0.30 %
	AL:3=0.96 %	AL:3=0.96 %	PA:3=0.47 %
	AL:4=1.19 %	AL:4=1.19 %	PA:4=0.64 %
	AL:5=1.43 %	AL:5=1.43 %	PA:5=0.81 %
	AL:6=1.66 %	AL:6=1.66 %	PA:6=0.99 %
	AL:7=1.89 %	AL:7=1.89 %	PA:7=1.16 %
	AL:8=2.12 %*	AL:8=2.12 %*	PA:8=1.33 %*
	AL:9=2.35 %	AL:9=2.35 %	PA:9=1.50 %
Ion SMOKE (ION)  (See notes <sup>1</sup> and <sup>2</sup> )	AL:1=0.50 %	AL:1=0.50 %	PA:1=Auto
	AL:2=0.75 %	AL:2=0.75 %	PA:2=0.40 %
	AL:3=1.00 %	AL:3=1.00 %	PA:3=0.50 %
	AL:4=1.25 %	AL:4=1.25 %	PA:4=0.75 %
	AL:5=1.50 %	AL:5=1.50 %	PA:5=1.00 %
	AL:6=1.75 %*	AL:6=1.75 %*	PA:6=1.25 %*
	AL:7=2.00 %	AL:7=2.00 %	PA:7=1.50 %
	AL:8=2.25 %	AL:8=2.25 %	PA:8=1.75 %
	AL:9=2.50 %	AL:9=2.50 %	PA:9=2.00 %
FlashScan View  (See Note <sup>3</sup> )	AL:1=0.03 %	AL:1=0.03 %	PA:1=Auto
	AL:2=0.05 %	AL:2=0.05 %	PA:2=0.02 %
	AL:3=0.10 %	AL:3=0.10 %	PA:3=0.03 %
	AL:4=0.20 %	AL:4=0.20 %	PA:4=0.05 %
	AL:5=0.30 %	AL:5=0.30 %	PA:5=0.10 %
	AL:6=0.50 %*	AL:6=0.50 %*	PA:6=0.20 %*
	AL:7=0.70 %	AL:7=0.70 %	PA:7=0.30 %
	AL:8=0.80 %	AL:8=0.80 %	PA:8=0.40 %
	AL:9=1.00 %	AL:9=1.00 %	PA:9=0.50 %
Acclimate Plus <sup>TM</sup>		<b>Alarm (CLIP)</b>	
	AL:1=0.50 %	AL:1=1.00 %	PA:1=0.50%
	AL:2=1.00 %	AL:2=1.00 %	PA:2=1.00 %
	AL:3=1.00 to 2.00 %	AL:3=1.00 to 2.00 %	PA:3=1.00 %
	AL:4=2.00 %	AL:4=2.00 %	PA:4=1.00 to 2.00%
	AL:5=2.00 to 3.00%*	AL:5=2.00 to 4.00%*	PA:5=1.00 to 2.00 %*
	AL:6=3.00 %	AL:6=2.00 to 4.00%	PA:6=2.00 %
	AL:7=3.00 to 4.00 %	AL:7=2.00 to 4.00%	PA:7=2.00 %
	AL:8=4.00 %	AL:8=4.00 %	PA:8=2.00 to 3.00 %
AL:9=thermal 135°F	AL:9=4.00%	PA:9=2.00 to 3.00 %	

1. Suitable for open area protection only with 0 to 300 feet per minute air velocity.
2. Use only alarm sensitivity setting of AL=1, AL=2 or AL=3 for ION detectors installed in Canada
3. The use of alarm sensitivities below 0.50% obscuration per foot requires a 90 day test to ensure that the environment for the detectors is suitable for the higher sensitivity setting. (Refer to “How to Test Detectors Set Below 0.50% Obscuration per Foot” on page 91.)

**Table 30 Detector Sensitivity (in percent obscuration per foot)**

### How to Test Detectors Set Below 0.50% Obscuration per Foot

Using alarm sensitivities below 0.50% obscuration per foot requires a 90-day test to ensure that the detector environment is suitable for the higher sensitivity setting. To meet Notifier and Underwriters Laboratory requirements, test each detector planned to operate below 0.50%/ft obscuration as follows:

1. Set the detector as follows:

Step	Action
1	Initially set to the 0.50% obscuration per foot Alarm level.
2	Set the Pre-Alarm level to the desired final Alarm sensitivity.
3	Set the Pre-Alarm to Alert mode (non-latching).

2. Operate detectors continuously for 90 days with all environmental factors (such as, temperature, humidity, air flow, occupancy, and so on) similar to the intended application for the detectors. Record all events for each tested detector with an electronic History buffer or a printout.
3. At the end of the 90-day test: An authorized Notifier representative, or an end user trained by an authorized Notifier representative must inspect the results of the test. If the test results show no alarms or pre-alarms for the tested detectors, reprogram the fire alarm system to set the Alarm sensitivity to the more sensitive Pre-Alarm level of the test.

## Detector Maintenance Features

### Overview

The NFS-640 provides features to check the maintenance performance level of addressable, intelligent detectors. Detector maintenance features include the following:

- View detector maintenance information for an individual detector
- Print a detector maintenance report for all detectors

### How to Access Detector Maintenance Information

1. Access detector maintenance functions by pressing the ENTER key. The control panel displays the Program Entry screen:

```

┌=PROGRAMMING           ┐=READ STATUS ENTRY
(ESCAPE TO ABORT)
  
```

2. From the Program Entry screen, press the M key. The control panel displays the Detector Maintenance Selection screen:

```

SLC loop ───────────┐ Three digit address
Select Detector Address (LDAAA) <ENTER>
or Press P, <ENTER> for print all.
  
```

3. Press **1** or **2** to specify the SLC loop, then the detector's three digit address, then press the ENTER key; or to print a Detector Maintenance Report (Figure 31 on page 93): Press **P**; then, press the ENTER key.

### View Detector Maintenance for a Detector

When you enter the detector SLC address the control panel displays the Detector Maintenance Status screen as shown below:

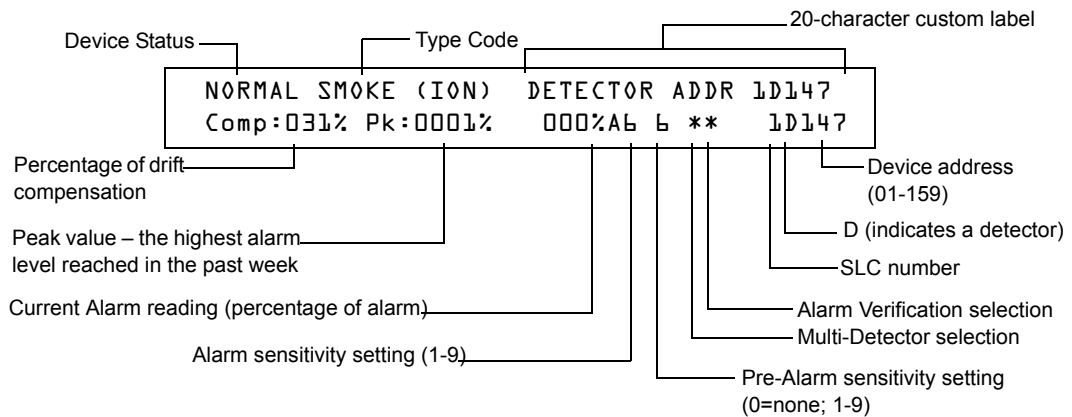

**Figure 30 Detector Maintenance Status Screen**

Once you display information for a detector, you can use the **+** (Next Selection) and **-** (Previous Selection) keys to view information for the next or previous detector on the SLC.

Refer to “How to Interpret a Detector Status Display or Maintenance Report” on page 93 for descriptions of each item.

## Print a Detector Maintenance Report

A Detector Maintenance Report lists detector maintenance status for each installed addressable detector [except FDX-551 (an analog heat detector)].

When you press and enter the P key the control panel sends a Detector Maintenance Report (Figure 31) to the printer connected to the control panel.

```

Detector Maintenance Report
1
*** PRINT SMOKE DETECTOR MAINTENANCE ***
NORMAL SMOKE (PHOTO) INTENSIVE CARE UNIT Comp:032% Pk:0002% 000% A8 8 ** 1D043
NORMAL SMOKE (PHOTO) DETECTOR ADDR 1D044 Comp:027% Pk:0001% 000% A8 8 ** 1D044
NORMAL SMOKE (PHOTO) DETECTOR ADDR 1D045 Comp:028% Pk:0001% 000% A8 8 ** 1D045
NORMAL SMOKE (PHOTO) DETECTOR ADDR 1D046 Comp:030% Pk:0001% 000% A8 8 ** 1D046
NORMAL SMOKE (PHOTO) DETECTOR ADDR 1D047 Comp:024% Pk:0002% 000% A8 8 ** 1D047
NORMAL SMOKE (PHOTO) DETECTOR ADDR 1D048 Comp:031% Pk:0002% 000% A8 8 ** 1D048
NORMAL SMOKE (PHOTO) DETECTOR ADDR 1D049 Comp:033% Pk:0002% 000% A8 8 ** 1D049
NORMAL SMOKE (PHOTO) DETECTOR ADDR 1D050 Comp:008% Pk:0003% 000% A8 8 ** 1D050
***** PRINT END *****
    
```

**Figure 31 Sample Detector Maintenance Report**

## How to Interpret a Detector Status Display or Maintenance Report

Detector Maintenance Status Screens and Detector Maintenance Reports provide the same information (such as Device Status, Compensation, Peak Value) about a detector. This section contains descriptions of each item that appears in a Detector Maintenance Status Screen or a Detector Maintenance Report.

```

NORMAL SMOKE (PHOTO) DETECTOR ADDR 1D044 Comp:027% Pk:0001% 000% A8 8 C * 1D044
      1           2           3           4           5           6           7 8 9 10 11
    
```

- Device Status** (NORMAL) The status of the detector: NORMAL, ALARM, DISABL OR TEST.
- Type Code** (SMOKE (PHOTO)) The software Type Code that identifies the type of detector. Refer to “Type Codes for Intelligent Detectors” on page 104.
- Custom Label** (DETECTOR ADDR 1D044) The 19-character user-defined custom label.
- Drift Compensation** (COMP:027%) The relative cleanliness of a detector determined by sampling the amount of contaminants in the detector, ambient air conditions, and the age of the detector. The Comp value also indicates if a detector requires maintenance. Refer to “Maintenance Warnings – Three Levels” on page 85 for definitions of maintenance levels. The table below contains a list of the maintenance level values for each type of detector:

Type of Detector	Normal	Low Chamber Reading	Maint. Alert	Maint. Urgent
Ion	006-068	less than 006	92-99	100
Photo	006-069	less than 006	93-99	100
Laser	003-063	less than 003	83-99	100
Acclimate Plus™	n/a	LO-VAL	Dirty1	Dirty2

**Table 31 Maintenance Levels by Detector Type**

- Peak Value** (PK:0001%) The highest analog value reached by the detector during the past week. The peak value slowly returns to zero.
- Alarm Reading** (000%) The current alarm reading of the detector, as a percentage of the Alarm Sensitivity setting.
- Alarm Sensitivity Setting** (A8) The Alarm Sensitivity (x=1-9) entered in the Detector Sensitivity Screen.

8. **Pre-Alarm Sensitivity Setting** (8) The Pre-Alarm Sensitivity (1-9; 0 = Pre-Alarm not used) entered in the Detector Settings Screen. Refer to “Detector Sensitivity Settings” on page 90 for more information on the Pre-Alarm sensitivity settings.
9. **Multi-Detector Selection** (\*) A smoke detector programmed so that it evaluates readings from nearby detectors in making Alarm or Pre-Alarm decisions. Cooperative Multi-Detector sensing also allows the combination of ionization with photoelectric technology in reaching an alarm decision. See “How to Modify an Addressable Detector Point” on page 22 for instructions on setting Cooperative Multi-Detector Settings.
  - \* – Multi-not used.
  - A – combines the detector’s alarm decision with the next address above.
  - B – combines the detector’s alarm decision with the next address below.
  - C – combines the detector’s alarm decision with the next address above and the next address below.
10. **Alarm Verification** (\*)
  - \* – Alarm Verification not programmed for this detector.
  - V – Alarm Verification enabled.
  - xx – Alarm Verification programmed for the detector; xx equals the Verification Counter (00-99). See “How to Modify an Addressable Detector Point” on page 22 for instructions on setting Alarm Verification.
11. **Device SLC Address** (1D044) The SLC address of the detector.

# Appendix D: CBE (Control-By-Event)

## Description

CBE (Control-By-Event) is a software function that provides a means to program a variety of output responses based on various initiating events. The control panel operates Control-By-Event (CBE) through 99 Software Zones with the following features:

- Each input point (detector, monitor module) can list up to five Software Zones
- Each output point (control module, NAC, Panel Circuit) can list up to five Software Zones
- Output points can list zone Z00 (general alarm). Non-Alarm or Supervisory points do not activate Software Zone Z00 (general alarm)

## Input and Outputs

Input and output devices with CBE-listed Software Zones work as follows:

These devices	Operate with CBE as follows
Inputs (detectors, monitor modules)	When an input device activates, so do all Software Zones listed to the input device.
Outputs (control modules and NACs, and Panel Circuits)	When a Software Zone activates, the output device(s) in that zone turns on.

## Equations

Space for up to twenty logic or time delay equations is included in the control panel. Each equation can be a logic equation or a time delay function. A time delay function can have a logic equation as an internal equation, but not vice versa. The rules of the equations are:

1. Equations can be entered, edited and viewed in the VeriFire™ Tools program, but can only be viewed on the control panel.
2. The twenty equations are designated in the panel as ZE0-ZE9 and ZL0-ZL9, and are evaluated in that order.

**Note:** In the VeriFire™ Tools program, ZL1 - ZL10 corresponds to ZE0-ZE9, and ZL11 - ZL20 corresponds to ZL0-ZL9.

3. Equations will always begin with a logic or a time delay function.
4. Equations will be a maximum of 73 characters long, including parentheses and commas.
5. Equations can have a maximum of 10 logic functions. The function set is listed below in “Equation Entry” on page 96.
6. These equations are to be evaluated after all other devices have been evaluated.
7. One logic equation can be used as a variable in another equation only if the equation used has previously been evaluated. For example, the results of the ZE0 equation can be used in the ZL5 equation but the opposite is not true.
8. Time delay equations can use any other functions as an internal equation, but the other function can not use time delay equation as an internal equation.
9. A logic instruction can have a maximum of 20 arguments (inclusive start and stop address).
10. Maximum for the delay timer is 18 hours 12 minutes.

## Equation Entry

The equations must be entered using the VeriFire™ Tools Program Utility. All are subject to the maximum number of arguments possible in a logic instruction as discussed above (Item Number 9 on page 95).

### Logic Functions

#### The “AND” Operator

Requires that each argument be in alarm.

Example: AND(Z02,Z05,Z09)

All three arguments in the equation must be in alarm for the output point to be activated.

#### The “OR” Operator

Requires that any argument be in alarm

Example: OR(Z02,Z05,Z09)

If any one of the three arguments in the equation is in alarm the output point will be activated.

#### The “NOT” Operator

Inverts the state of the argument (activated to deactivated OR deactivated to activated).

Example: NOT(Z02)

The output point will remain activated until the argument goes into alarm.

If the argument goes into alarm the output point will deactivate.

#### The “ONLY1” Operator

Requires that only one argument be in alarm.

Example: ONLY1(Z02,Z05,Z09)

If only one of the arguments is in alarm the output point will be activated.

#### The “ANY2” Operator

Requires that two or more arguments be in alarm.

Example: ANY2(Z02,Z05,Z09)

If any two or more of the arguments are in alarm the output point will be activated.

#### The “ANY3” Operator

Requires that three or more arguments be in alarm.

Example: ANY3(Z02,Z05,Z07,Z09)

If any three or more of the arguments are in alarm the output point will be activated.

#### The “XZONE” Operator

Requires that any combination of two or more input devices programmed to a zone be in alarm.

Example: XZONE(Z02)

If any combination of two or more initiating devices that have been programmed (CBE) to this software zone comes into alarm, then this output point will be activated.

#### The “RANGE” Operator

Each argument within the range must conform to the requirements of the governing operator. The range limit is 20 consecutive arguments.

Example: AND(RANGE(Z1,Z20))

Zone 1 through Zone 20 must all be in alarm for the output point to be activated.



## Equation Syntax Example

**OR(AND(L1D1,L1D4),AND(L2D6,L2M3,NOT(L2M4)),ANY2(L1M13,L1M14,L1M15))**

Equation begins with a logic or time delay function - OR

*67 Characters* (maximum of 73) - includes parentheses and commas.

*5 Logic Functions* (maximum of 10) - OR, AND, AND, NOT and ANY2.

*8 Arguments* (maximum of 20 per logic function) - L1D1,L1D4,L2D6,L2M3,L2M4....

The equation contains no spaces.

## Evaluating an Equation

When you evaluate an equation, you start from the innermost part of the equation and work outwards. For this equation to evaluate TRUE and thus turn on any output mapped to it, the following conditions must be met:

**OR(AND(L1D1,L1D4),AND(L2D6,L2M3,NOT(L2M4)),ANY2(L1M13,L1M14,L1M15))**

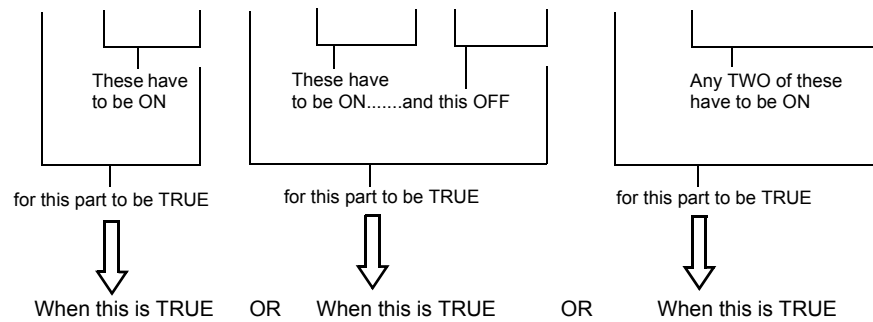

Then all outputs programmed with this equation will be turned ON.

## Argument Entries

The argument entries of the logic functions can be another logic function or any of the devices listed below:

1D1 – 1D159	detectors loop 1	(159)
1M1 – 1M159	modules loop 1	(159)
2D1 – 2D159	detectors loop 2	(159)
2M1 – 2M159	modules loop 2	(159)
P1-P64	S5000 Modules	(64)
B1 – B4	panel bells	(4)
Z0 – Z99	zones	(100)
F0 – F9	special function zones	(10)
R0 – R9	releasing zones	(10)
ZE0 – ZE9*	equations 0-9	(10)
ZL0 – ZL9**	equations 10-19	(10)
*Corresponds in VeriFire™ Tools to ZL1-ZL10		
**Corresponds in VeriFire™ Tools to ZL11-ZL20		

Equations must be evaluated before use in another equation.

## Time Delay Functions

### The “DEL” Operator

Used for delayed operation

Example: DEL(HH:MM:SS HH:MM:SS,ZE5)

- The first HH:MM:SS is the delay time, the second HH:MM:SS is the duration time.
- If delay of zero is entered (00.00.00), the equation will evaluate true as soon as the internal equation (ZE5) evaluates true and will remain that way for the specified duration, unless the internal equation becomes false.
- If no duration is specified, then the device will not be deactivated until a reset occurs or the internal equation evaluates false.

### The “SDEL” Operator

A latched version of the DEL operator. Once the equation evaluates true, it remains activated until a reset, even if the internal equation (ZE5) becomes false.

Example: SDEL(HH:MM:SS HH:MM:SS,ZE5)

- The first HH:MM:SS is the delay time, the second HH:MM:SS is the duration time.
- If delay of zero is entered (00.00.00), the equation will evaluate true as soon as the internal equation (ZE5) evaluates true and will remain that way for the specified duration.
- If no duration is specified, then the device will not deactivate until reset.

The installer can enter the equations in any combination wanted as long as the format of the logic function or time delay is followed from the lists above. Error checking will be performed after the user has entered the complete equation. Possible errors are too many or too few parentheses, too many or too few arguments inside the parentheses, unknown function and unknown device type.

### CBE Example

An example of CBE, where monitor module 1M101 lists zone Z04 and Z05, and control module 1M108 lists zone Z05 and zone Z07:

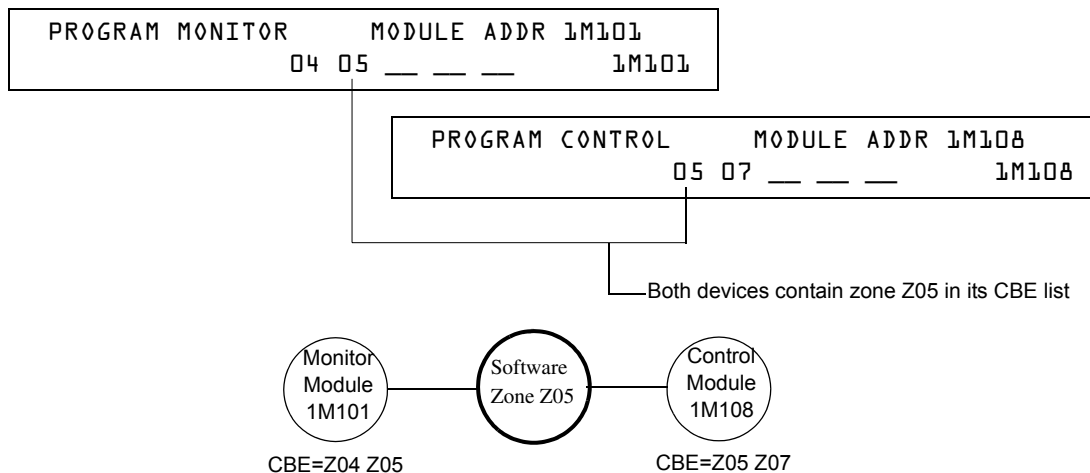

**Figure 32 CBE Example**

When monitor module 1M101 activates, the following CBE takes place:

1. Software Zones Z04 and Z05 activate.
2. Since control module 1M108 has Z05 in its CBE list, all of its outputs would activate. All output devices with Z04 or Z05 would activate.

## Notes

# Appendix E: Detector Initialization

## Overview

The control panel automatically performs a detector initialization routine when you add or change a detector, unless the control panel is in Walk Test or Advanced Walk Test. If you change a detector with the control panel in Walk Test or Advanced Walk Test, you must manually initialize the detector as detailed in “How to Manually Initialize a Detector” on page 102. The detector initialization routine takes approximately 2.5 minutes, during which time the FACP remains in service. While initializing a detector, follow these guidelines:

- Make sure the detector is free of residual smoke during detector initialization.
- Do not test a detector during detector initialization.

**Note:** The control panel only performs detector initialization if it senses that a detector was removed for at least 15 seconds. This is what actually “turns on” the detector. It is an automatic procedure but is specified here because of the delay between detector connection and full function. The rest of the system remains in full service during this time.

A sample screen that appears on the LCD display during detector initialization.

```
Detector Initializing _ Please Wait
                        02:48P 071401 Sat
```

**Figure 33 Detector Initialization Screen**



**WARNING:** If you replace any detector with a different type of detector (for example, replace a laser detector with a photoelectric detector), you must immediately program the control panel with the new detector Type Code. Failure to do so can cause incorrect control panel operation, including false alarms. For instructions on replacing a detector, refer to “How to Replace a Detector” on page 101.

## System Testing and Detector Initialization

To facilitate system testing, the control panel does not initialize detectors during Walk Test and Advanced Walk Test. You can remove a detector to confirm supervision, then replace the detector for immediate testing. If you replace a removed detector with a different detector of the same type, you must manually initialize the detector according to the instructions in “How to Manually Initialize a Detector” on page 102. If, however, you want to replace a removed detector with a different type of detector, refer to “How to Replace a Detector” on page 101.

## How to Replace a Detector

If you replace a detector with a different type of detector, you must immediately program the control panel for the new detector type. To replace a detector, follow these steps:

**Note:** Parentheses show an example of replacing an existing photoelectric detector at address 1D101 with a laser detector.

Step	Action
1	Disable the point of the detector. (point 1D101)
2	Remove the photoelectric detector and replace with laser detector set to the same address.
3	Autoprogram the panel to recognize the new detector type.
4	Enable new detector.

## How to Manually Initialize a Detector

You only need to manually initialize a detector when you change a detector during Walk Test or Advanced Walk Test. If, however, you replace a detector with a different type of detector, you must immediately program the new detector according to the instructions in “How to Replace a Detector” on page 101.

To manually initialize a detector, follow these steps:

1. Press the ENTER key. The control panel displays the Program Entry screen:

```

1=PROGRAMMING      2=READ STATUS ENTRY
(ESCAPE TO ABORT)

```

2. Press the 1 key. The control panel displays the Enter Password screen:

```

ENTER PROG OR STAT PASSWORD, THEN ENTER.
(ESCAPE TO ABORT)

```

3. Enter the password RESET, which starts detector initialization. The control panel displays the following three screens, in the sequence shown, while initializing a detector:

```

CHECKING MEMORY NFS-640 Release 1.0
Software #XXXXXXX

```

```

Detector Initializing _ Please Wait
02:48P 071401 Sat

```

When the control panel completes the detector initialization, it displays system status as shown below:

```

SYSTEM NORMAL      02:50P 071401 Sat

```

# Appendix F: Type Codes

## What are Type Codes?

Type Codes are software selections that you select for initiating devices (detectors and monitor modules) and output devices (control modules, NACs, and Panel Circuits). Some Type Codes are self-explanatory; that is, the Type Code matches the function of the device, such as a “Monitor” for a monitor module, “Photo” for a photoelectric detector, and so on. Type codes also provide special functions, such as activating switches, solenoids, and control panel functions.

## How to Select a Type Code

You select a Type Code through the Point Programming screen. For instructions, refer to “How to Modify or Delete a Point (2=point)” on page 21.

## In this Appendix

This appendix contains detailed descriptions of Type Codes for input and output devices, as listed below:

<b>Type of Device</b>	<b>Refer to page</b>
Type Codes for Intelligent Detectors	104
Type Codes for Monitor Modules	105
Type Codes for Control Modules	106
NAC and Panel Circuit Type Codes	107

## Type Codes for Input Devices

### Overview

This section provides Type Codes for intelligent detectors and monitor modules. For instructions on programming Type Codes, refer to “How to Modify or Delete a Point (2=point)” on page 21.

### Type Codes for Intelligent Detectors

A list of intelligent detector Type Codes, which specify the type of detector installed at an SLC address.

Type Code	Point Type	Point Characteristics		Device Function
		Latching (Y/N)	Point Function	
SMOKE (ION)	fire alarm	Y	lights fire alarm LED and activates CBE	Ionization smoke detector
SMOKE(DUCTI)	fire alarm	Y	lights fire alarm LED and activates CBE	Duct Ionization smoke detector
SUP.T(DUCTI)**	supervisory	N	lights supervisory LED	Ionization smoke detector used as a duct detector to report supervisory condition rather than alarm. Tracking.
SUP.L(DUCTI)	supervisory	Y	lights supervisory LED	Ionization smoke detector used as a duct detector to report supervisory condition rather than alarm. Latching.
SUP.T(ION)**	supervisory	N	lights supervisory LED	Ionization smoke detector used to report supervisory condition rather than alarm. Tracking.
SUP.L(ION)	supervisory	Y	lights supervisory LED	Ionization smoke detector used to report supervisory condition rather than alarm. Latching.
SMOKE(PHOTO)	fire alarm	Y	lights fire alarm LED and activates CBE	Photoelectric smoke detector
SMOKE(DUCTP)	fire alarm	Y	lights fire alarm LED and activates CBE	Duct Photoelectric smoke detector
SUP.T(DUCTP)**	supervisory	N	lights supervisory LED	Photoelectric smoke detector used as a duct detector to report supervisory condition rather than alarm. Tracking.
SUP.L(DUCTP)	supervisory	Y	lights supervisory LED	Photoelectric smoke detector used as a duct detector to report supervisory condition rather than alarm. Latching.
SUP.T(PHOTO)**	supervisory	N	lights supervisory LED	Photoelectric smoke detector used to report supervisory condition rather than alarm. Tracking.
SUP.L(PHOTO)	supervisory	Y	lights supervisory LED	Photoelectric smoke detector used to report supervisory condition rather than alarm. Latching.
RF_SMOKE	fire alarm	Y	lights fire alarm LED and activates CBE	Wireless Photoelectric smoke detector
SMOKE(HARSH)*	fire alarm	Y	lights fire alarm LED and activates CBE	HARSH smoke detector
SMOKE(LASER)	fire alarm	Y	lights fire alarm LED and activates CBE	Laser smoke detector
AIR REF	fire alarm	Y	lights fire alarm LED and activates CBE	Assign to one or more FSL-751 detectors used to monitor the quality of air entering the protected area. The air quality measurement allows the VIEW® system to compensate for vehicle fumes, fog, or other particles brought into the protected area through the ventilation system. Poor air quality will lower the sensitivity of all FSL-751 detectors on the SLC. The detector sensitivity, however, remains within approved limits (always less than 1% obscuration per foot).
<p><b>Note:</b> A reference detector still functions as a smoke detector, but you should set the detector sensitivity level to the least sensitive level—AL:9 and PA:9 Change Alarm and Pre-Alarm sensitivity. Refer to “Detector Sensitivity Settings” on page 90 for a complete list of detector sensitivity settings.</p>				
HEAT	fire alarm	Y	lights fire alarm LED and activates CBE	190°F intelligent thermal sensor
HEAT+	fire alarm	Y	lights fire alarm LED and activates CBE	190°F intelligent thermal sensor with low temperature warning.
HEAT(ANALOG)	fire alarm	Y	lights fire alarm LED and activates CBE	135°F intelligent thermal sensor
HEAT (ROR)	fire alarm	Y	lights fire alarm LED and activates CBE	15°F per minute rate-of-rise detector
SMOKE ACCLIM	fire alarm	Y	lights fire alarm LED and activates CBE	Combination Photoelectric/heat detector without freeze warning (Acclimate Plus™)
SMOKE(ACCLI+)	fire alarm	Y	lights fire alarm LED and activates CBE	Combination Photoelectric/heat detector with freeze warning (Acclimate Plus™)
SMOKE(MULTI)*	fire alarm	Y	lights fire alarm LED and activates CBE	Multisensor smoke detector
* CLIP Mode only				
**Not suitable for Canadian applications.				

**Table 32 Intelligent Detector Type Codes**



## Type Codes for Monitor Modules

A list of monitor module Type Codes, which you can use to change the function of a monitor module point.

Type Code	Point Type	Point Characteristics		Device Function
		Latching (Y/N)	Point Function	
MONITOR	fire alarm	Y	Lights fire alarm LED and activates CBE	Alarm-monitoring device
PULL STATION	fire alarm	Y	Lights fire alarm LED and activates CBE	Manual fire-alarm-activating device, such as a pull station
RF MON MODUL	fire alarm	Y	Lights fire alarm LED and activates CBE	Wireless alarm-monitoring device
RF PULL STA	fire alarm	Y	Lights fire alarm LED and activates CBE	Wireless manual fire-alarm-activating device, such as a pull station
SMOKE CONVEN	fire alarm	Y	Lights fire alarm LED and activates CBE	Indicates activation of a conventional smoke detector attached to an FZM-1
SMOKE DETECT	fire alarm	Y	Lights fire alarm LED and activates CBE	Indicates activation of a conventional smoke detector attached to an FZM-1
WATERFLOW	fire alarm	Y	Lights fire alarm LED and activates CBE	Monitor for waterflow alarm switch
WATERFLOW S	supervisory	Y	Lights supervisory LED and activates CBE	Indicates supervisory condition for activated waterflow switch
ACCESS MONTR	non-alarm	N	Activates CBE	Used for monitoring building access
AREA MONITOR	security	Y	Lights security LED and activates CBE	Monitors building access
AUDIO SYSTEM	trouble	N	Activates CBE and lights trouble LED	Used for monitoring audio equipment
EQUIP MONTR	trouble	N	Activates CBE and lights trouble LED	Used for recording access to monitored equipment
RF SUPERVSRY	supervisory	N	Lights Supervisory LED	Monitors a radio frequency device
SECURITY	security	Y	Lights security LED	Indicates activation of security alarm
LATCH SUPERV	supervisory	Y	Lights supervisory LED	Indicates latching supervisory condition
TRACK SUPERV	supervisory	N	Lights supervisory LED	Monitors for waterflow tamper switches for alarm points
SPRINKLR SYS	supervisory	Y	Lights supervisory LED	Monitors a waterflow device
SYS MONITOR	security	Y	Lights security LED and activates CBE	Monitors equipment security
TAMPER	supervisory	Y	Lights supervisory LED, activates CBE	Indicates activation of tamper switch
ACK SWITCH	non-alarm	N	Emulates panel Acknowledge switch, no CBE	Silences panel sounder, gives an Acknowledge message on the panel LCD
ALLCALL PAGE	non-alarm	N	Activates all speaker circuits, no CBE	Emulates AMG-1 All-call switch
DRILL SWITCH	non-alarm	N	Emulates panel Drill switch	Activates silenceable outputs
EVACUATE SWITCH	non-alarm	N	Emulates keypad Drill Switch	Activates all silenceable outputs
FIRE CONTROL	non-alarm	Y	Activates CBE	Used for non-fire activation of outputs
NON FIRE	non-alarm	N	Activates CBE	Used for building energy management
PAS INHIBIT	non-alarm	N	Inhibits Positive Alarm Sequence	Inhibits Positive Alarm Sequence
POWER MONTR	trouble	N	Indicates trouble, activates CBE	Monitors auxiliary power supplies
RESET SWITCH	non-alarm	N	Emulates keypad Reset switch	Resets control panel
SIL SWITCH	non alarm	N	Emulates keypad Signal Silence switch	Turns off all activated silenceable outputs
TELE PAGE	non-alarm	N	Emulates Page Button on FFT-7	Allows remote paging to a fire area
TROUBLE MON	trouble	N	Indicates Trouble and activates CBE	Monitors trouble inputs
ABORT SWITCH	non alarm	N	Indicates Active at the panel	Aborts activation of a releasing zone
MAN RELEASE	fire alarm	Y	Lights Fire Alarm LED and activates CBE	Indicates activation of a monitor module programmed to releasing zone to perform a releasing function
MANREL DELAY	fire alarm	Y	Lights Fire Alarm LED and activates CBE	Indicates activation of a monitor module programmed for a release output
SECOND SHOT	fire alarm	Y	Indicates Active at the panel and activates CBE	Provides second activation of releasing zone after soak timer has expired.
Blank	fire alarm	Y	Lights fire alarm LED and activates CBE	Monitors for a device with no description
HEAT DETECT	fire alarm	Y	Lights fire alarm LED and activates CBE	Monitors for conventional heat detector

**Table 33 Type Codes for Monitor Modules**

## Type Codes for Output Devices

### Overview

This section provides Type Codes for control modules, NACs, and Panel Circuits. For instructions on programming Type Codes, refer to “How to Modify or Delete a Point (2=point)” on page 21.

### Type Codes for Control Modules

A comprehensive list of control module Type Codes, which you can select to change the function of an control module point.

Type Code	Silenceable (Y/N)	Configuration	Device Function
CONTROL	Y	NAC	Supervised NAC for notification appliance
RELAY	Y	Form-C relay	Relay output
BELL CIRCUIT	Y	NAC	Supervised NAC for notification appliance
STROBE CKT	Y	NAC	Supervised NAC for notification appliance
HORN CIRCUIT	Y	NAC	Supervised NAC for notification appliance
AUDIBLE CKT	Y	NAC	Supervised NAC for notification appliance
SPEAKER	Y	NAC	Supervised NAC for notification appliance
ISOLATED NAC	Y	NAC	Supervised NAC for notification appliance, used with audio isolators. Activates even if there is a short on its NAC circuit. For ULC installations only.
ISOLATED SPK	Y	NAC	Supervised NAC for speaker circuits, used with audio isolators. Activates even if there is a short on its audio circuit. For ULC installations only.
REL END BELL	N	NAC	Supervised NAC for notification appliance
blank	Y	NAC	Supervised NAC (for use when no other Type Code applies)
REL CKT ULC	N	NAC	Releasing Circuit, power-limited, supervised for opens, shorts and ground faults (always non-silenceable)
RELEASE CKT	N	NAC	Releasing circuit, nonpower-limited, supervised for opens and ground faults
RELEA.FORM C	N	Form-C Relay	Relay output, contacts operate upon release
REL AUDIBLE	Y	NAC	NAC, activated upon release
NONRESET CTL	N	Form-C Relay and NAC	Relay output, unaffected by “System Reset” command
TELEPHONE	N	NAC	Standard Telephone circuit
INSTANT RELE	N	NAC	NAC, short = normal; supervised for open circuits and ground faults. Always non-silenceable and switch-inhibited.
ALARMS PEND.	N	NAC	Output that will activate upon receipt of an alarm condition, and remain in the alarm state until all alarms have been acknowledged. It is programmed as “switch inhibit”.
CONTROL NAC	Y	NAC	Supervised NAC
GEN ALARM	N	NAC	Control Module, an XPC-8 circuit, or an XP5-C (in NAC mode) configured as a Municipal Box Transmitter for NFPA 72-1999 Auxiliary Fire Alarm Systems applications. This Type ID can also be used for general alarm activation. It is programmed as “switch inhibit”.
GEN SUPERVIS	N	NAC	Control Module, an XPR-8 relay, or an XP5-C (in relay mode) activated under any Supervisory condition (includes sprinkler type). It is programmed as “switch inhibit”.
GEN TROUBLE	N	NAC	Control Module, an XPR-8 relay, or an XP5-C (in relay mode) activated under any System Trouble condition. It is programmed as “switch inhibit”.
GENERAL PEND	N	NAC	Control Module, an XPC-8 circuit, or an XP5-C (in NAC mode) that will activate upon receipt of an alarm and/or trouble condition, and remain in the ON state until all events have been ACKNOWLEDGED.
TROUBLE PEND	N	NAC	Control Module, an XPC-8 circuit, or an XP5-C (in NAC mode) that will activate upon receipt of a trouble condition, and remain in the ON state until all troubles have been ACKNOWLEDGED. It is programmed as “switch inhibit”.

**Table 34 Control Module Type Codes**

## NAC and Panel Circuit Type Codes

A comprehensive list of Type Codes for panel NACs and Panel Circuits. The Type Codes that display, however, depend on the type of circuit: NAC or Panel Circuit relay. For instructions on programming Type Codes, refer to “How to Modify or Delete a Point (2=point)” on page 21.

**Note:** Do not assign Releasing Type Codes to Panel Circuits with the exception of the audible Type Codes REL END BELL and REL AUDIBLE.

Type Code	Silenceable (Y/N)	Configuration	Device Function
CONTROL	Y	Panel Circuit relay or NAC	Supervised NAC
RELAY	Y	Panel Circuit relay	Relay output
BELL CIRCUIT	Y	Panel Circuit relay or NAC	Supervised NAC for notification appliance
STROBE CKT	Y	Panel Circuit relay or NAC	Supervised NAC for notification appliance
HORN CIRCUIT	Y	Panel Circuit relay or NAC	Supervised NAC for notification appliance
AUDIBLE CKT	Y	Panel Circuit relay or NAC	Supervised NAC for notification appliance
SPEAKER	N	Panel Circuit relay only	Supervised NAC for speaker circuits
REL END BELL	N	Panel Circuit or NAC	Supervised NAC
blank label	Y	Panel Circuit relay or NAC	Supervised NAC for undefined device
REL CKT ULC	N	NAC	Releasing Circuit, power-limited, supervised for opens, shorts and ground faults (always non-silenceable)
RELEASE CKT	N	NAC	Releasing circuit, nonpower-limited, supervised for opens and ground faults
REL AUDIBLE	Y	Panel Circuit or NAC	NAC, activated upon release
TELEPHONE	N	Panel Circuit relay only	Standard Telephone circuit
REL CODE BELL	Y	NAC only	Supervised NAC (NFS-640 NAC only)
INSTANT RELE	N	NAC	NAC, short = normal; supervised for open circuits and ground faults. Always non-silenceable and switch-inhibited.
ALARMS PEND	N	Panel Circuit or NAC	Output that will activate upon receipt of an alarm condition, and remain in the alarm state until all alarms have been acknowledged. It is programmed as “switch inhibit”.
CONTROL NAC	Y	Panel Circuit relay or NAC	Supervised NAC
GEN ALARM	N	NAC	Control Module, an XPC-8 circuit, or an XP5-C (in NAC mode) configured as a Municipal Box Transmitter for NFPA 72-1999 Auxiliary Fire Alarm Systems applications (MBT-1 required). This Type ID can also be used for general alarm activation. It is programmed as “switch inhibit”.
GEN SUPERVIS	N	NAC	Control Module, an XPR-8 relay, or an XP5-C (in relay mode) activated under any Supervisory condition (includes sprinkler type). It is programmed as “switch inhibit”.
GEN TROUBLE	N	NAC	Control Module, an XPR-8 relay, or an XP5-C (in relay mode) activated under any System Trouble condition. It is programmed as “switch inhibit”.
GENERAL PEND	N	NAC	Control Module, an XPC-8 circuit, or an XP5-C (in NAC mode) that will activate upon receipt of an alarm and/or trouble condition, and remain in the ON state until all events have been ACKNOWLEDGED.
TROUBLE PEND	N	NAC	Control Module, an XPC-8 circuit, or an XP5-C (in NAC mode) that will activate upon receipt of a trouble condition, and remain in the ON state until all troubles have been ACKNOWLEDGED. It is programmed as “switch inhibit”.

**Table 35 NAC and Panel Circuit Type Codes**

## Notes

# Glossary

This section contains descriptions of terms essential to know when programming the control panel.

**Alarm History** See History buffer.

**Alarm Verification Timer** A user-defined global software timer function (set using Option 7=System at the Basic Programming screen) that can reduce the number of nuisance alarms. When you select Alarm Verification for a detector, the control panel delays an alarm signal for a user-specified time period. (The control panel ignores the Alarm Verification Timer if it detects another alarm or active detector during the verification period, or if another detector is already in the verification process.) Detectors with supervisory Type IDs can participate in Alarm Verification.

**Argument** An argument is a discreet part of a logic function used in a CBE logic equation. It can consist of panel/SLC addresses for detectors, modules, panel circuit modules, panel bells, zones, special function zones, releasing zones, or logic equations.

**Auto Silence Timer** A user-defined global software timer that functions like pressing the SIGNAL SILENCE key. For example, select 600. The control panel silences all active outputs programmed as silenceable. When the timer reaches 600 seconds (10 minutes), the control panel turns off all active outputs programmed as silenceable.

**Autoprogram** A software routine that directs the control panel to identify and automatically load SLC-connected devices into the program with default values for all parameters. The Autoprogram Finds and displays all new or missing intelligent detectors and modules--while ignoring devices already installed in memory--so you can edit default option selections. Typically, you Autoprogram the control panel as a first step in a new installation, or to add devices.

**AWACS™** (Advanced Warning Addressable Combustion Sensing) A set of software algorithms that provide the NFS-640 with industry-leading smoke detection capability.

**control module** An addressable module that a) switches power to a Style Y or Style Z NAC; or b) functions as a Form-C control relay.

**CBE** (Control-by-Event) A programming method that lets you map inputs and outputs to provide a variety of output responses based on various initiating conditions (events).

**CBE list** Inputs (detectors and monitor modules) and outputs (control modules, NACs, and Panel Circuits) provide up to five zone selections for CBE programming.

**CLIP** (Classic Loop Interface Protocol) Standard polling of each intelligent device on an SLC loop.

**Display and Control Center (DCC)** Term for a display location, programmed to participate in DCC, when it has control of Acknowledge, Signal Silence, Reset and Drill functions.

**Drift Compensation** An algorithm which permits the maintenance of a constant smoke detector sensitivity by accounting for environmental contaminants and other factors.

**download** A function for loading a system program from a file on a personal computer and storing the program in system memory of the control panel. Also see VeriFire™ Tools.

**FlashScan™** An algorithm that provides high-speed communication with analog intelligent devices on an SLC loop. Communication is in a grouped fashion. If one of the devices within the group has new information, the control panel stops the group poll and concentrates on single points.

**History buffer** The control panel maintains a history buffer of the last 800 events, each with a time and date stamp. History events include all alarms, troubles, operator actions, and programming entries. The control panel also maintains a 200-event Alarm History buffer, which consists of the 200 most recent alarm events from the 800-event history buffer.

**latching** An attribute of a device that keeps it in an active state until the condition causing the activation is corrected and the panel is reset.

**missing device** A device that exists in a program, but is not found by the control panel during Autoprogram, typically because the device is disconnected.

**FMM-1 module** An addressable monitor module that monitors conventional initiating devices.

**NAC** (Notification Appliance Circuit) A circuit or path directly connected to a notification appliance device (a fire alarm system component--such as a bell, speaker, strobe, and so on--that produces an audible output, a visual output, or both). On the NFS-640, a NAC is one of four output circuits on the Control Panel with addresses B01-B04, panel circuits, control modules or transponder points.

**new device** A device connected to the control panel, but not in program memory.

**non-latching** An attribute of a device that follows the state of the fire alarm system. That is, if a device is non-latching, it returns to its normal state automatically when the condition clears.

**Notification Appliance Circuit** see NAC.

**obscuration** A reduction in the atmospheric transparency caused by smoke, usually expressed in percent per foot.

**output circuit** A control module connected to the SLC, a device connected to one of the four NACs, or a Panel Circuit, such as an ICM-4.

**Panel Circuit** A circuit on a module connected to the control panel through connectors on the control panel. The control panel identifies a Panel Circuit with the addressing convention Px.x. For example P1.4, indicates Panel Circuit 4 on the first module connected to the control panel.

**point** A system memory address occupied by an addressable SLC device, Software Zone, or annunciator. For example, the control panel considers "1M102", a module on SLC 1 at SLC address 102, as a point.

**panel sounder** The piezo sounder on control panel, that pulses when troubles and alarms occur.

**Silence Inhibit Timer** A user-defined timer that disables the SIGNAL SILENCE key function for the programmed time (0-300 seconds) when a fire alarm occurs. The timer starts at the first alarm and restarts with each new alarm.

**SLC** (Signaling Line Circuit) A physical wire loop used to connect addressable detectors and modules to the control panel.

**Software Zone** A label, internal to the fire alarm system, assigned to a group of addressable devices.

**Special Annunciator** The NFS-640 supports ten point-addressable special annunciators: Annunciators 0 - 9, programmable only through the VeriFire™ Tools programming utility. For more information, refer to the VeriFire™ Tools CD on-line help .

**status banner** A text message in an LCD display that typically provides the description of the device or the status of a device.

**Switch Inhibit** A software function that lets you program control modules, NACs, and Panel Circuits so an operator cannot manually activate NAC or releasing circuits. With Switch Inhibit enabled, an operator cannot manually activate the NAC/releasing circuits from the control panel.

**SYSTEM NORMAL message** A message that displays, along with the current system date and time, on the bottom line of the LCD display during normal operation of the control panel.

**Terminal Interface** EIA-232 bidirectional serial port used for the upload and download functions.

**Terminal Mode** An operating mode for an LCD-80 or LCD-80TM that allows communication with the control panel through the EIA-485 port.

**Type Code** A Type Code is a software function that specifies the function of a detector, control module, monitor module, transponder point, NAC, or Panel Circuit point. (You can select a Type Code while programming a point). The Type Code specifies what action the control panel takes when the point activates. For example, when a monitor module with EVACUATE as a Type Code activates, the control panel activates all outputs, as if someone pressed the DRILL key.

**upload** A function for making a copy of a system program and storing the program as a file on a personal computer. Also see VeriFire™ Tools.

**View®** (Very Intelligent Early Warning) System A smoke detection system, consisting of the *NFS-640* control panel and FSL-751 laser detectors, that provides very early warning of smoldering fires.

**VeriFire™ Tools Program Utility** A software utility for uploading and downloading a system program between a personal computer and the control panel through the EIA-232 port.

**Walk Test** A feature that allows a single (qualified) maintenance person to test a fire alarm control panel and initiating devices without causing the control panel to enter into an alarm state.

**A**

- Abort Switch 29, 30, 53
  - basic configuration example 55
  - configuration example with monitor module 66
  - Definition 54
  - how it works 55
  - to program 54, 66
  - Type Code (ULL,IRI,NYC, or AHJ) 53
- AC delay enable 32
- Acclimate, detector sensitivity settings 90
- ACS Annunciation, releasing applications 78
- ACS annunciators
  - ACS Selection Groups A through M 35–39
  - annunciation points 34
  - annunciator display 34
  - Selection Groups, global setting 32
  - selection of display information 33
- Advanced Warning Addressable Combustion Sensing.
  - See AWACS Applications 84, 109
- AHJ Abort Switch
  - example 61
  - programming 61
- Alarm
  - Alarm Verification Timer 32
  - Scroll 43
  - to select sensitivity 90
- Alarm Verification Counters. See Detector headings. 49
- Alarm Verification Timer 32, 109
- annunciation points 34
- Argument 98, 109
- Auto Silence Timer 32, 109
- Autoprogram 15, 16–20, 109
  - default values 20
  - to add/remove device 18
  - to create a new program 17
- Auxiliary Control Functions, releasing applications 78
- AWACS Applications 84–94
  - Drift Compensation 84
  - Maintenance Warnings, 3 levels 85
  - Smoothing 84

**B**

- BACKUP option switch for NACs 53
- Basic Program 14, 15–41
- Baud rate
  - CRT Serial Port 45
  - Printer Serial Port 45
- Blink rate for SLC device LED 32

**C**

- California Code 29, 82
- Canadian Two-Stage 29, 82
- Caution
  - Definition 9
  - Do not program detectors as CLIP... 44
- CBE (Control-By-Event) 95–99
  - example 99

- CBE (Control-by-Event) 109
- CBE list 22, 80, 82, 109
- Check option (program errors) 41
- Clear memory 16
- CLIP (Classic Loop Interface Protocol) 14, 44
- Coding Function Selections 82
- Coding, Special Zone F8 20, 29, 31, 82
- Control Module
  - to program 24
- control module 109
- Cooperative Multi-Detector Sensing 87
- Cross Zone 29, 30, 53
  - programming example 63
  - to activate a Releasing Zone 62
  - Types 62, 63
- Custom label 22

**D**

- DCC (Display and Control Center) 109
- Delay Timer 29, 30, 53
  - to program 54
- Detector
  - Alarm Sensitivity Levels 86
  - Initialization and System Testing 101
  - Pre-Alarm Sensitivity Level 86
  - Print a Detector Maintenance Report 93
  - Program Values 22
    - to Access Detector Maintenance Information 92
    - to change sensitivity level 46, 48
    - to clear alarm verification counters 46, 49
    - to disable programmed points 46
    - to manually initialize 102
    - to program point 22
    - to replace 101
    - to Test Detectors Set Below 0.50% Obscuration per Foot 91
- Detector Initialization 101–102
- Device
  - to add 18
  - to remove 18
- download 109
- Drift Compensation 84, 109
  - graphic representation 85
- Dynamic Poll 43

**E**

- Equations
  - Argument Entries 98
  - Evaluating 97
  - logic and time delay 95
  - Logic Functions 96
  - rules 95
  - Time Delay Functions 98

**F**

- FlashScan
  - Devices, SLC options 44



Poll 14, 44

## G

Global System Functions 15  
     defaults 32  
     to change 32  
 Glossary 109

## H

History  
     Clear History 46, 49  
 History buffer 109  
 Holiday 20, 31  
 Holiday, special zone 29

## I

Initiating Devices, releasing zone 78  
 Instant Release Circuit  
     control module configuration example 76  
     to program 76  
 Ion FSI-751, detector sensitivity settings 90  
 IRI Abort Switch  
     example 58  
     to program 57

## L

Labels 22  
     note about spaces 22  
 latching 109  
 Local Control 43  
 LocM operating mode 32  
 LocT operating mode 32  
 Logic Functions 96

## M

Maintenance Levels by Detector Type 93  
 Maintenance Warnings 85  
 Manual Release Delay Switch  
     monitor module configuration example 68  
     to program 68  
 Manual Release Switch  
     monitor module configuration example 67  
     to program 67  
 Manually Initialization, detector 102  
 March Time 29, 82  
 Master Box trouble message 33  
 Monitor  
     default zones 23  
     to disable programmed points 46  
     to program monitor 23

## N

NAC (Notification Appliance Circuit) 110  
 NAC/Panel Circuit modules  
     to disable programmed points 46  
 NBG-12LRA 54, 66, 67, 68, 70  
 NCA (Network Control Annunciator) 12  
 Network node 42

Network Program 14, 42  
     network node number range 42  
 NFPA Standards for Releasing Applications 53  
 NFS-640 keypad 12  
 non-latching 110  
 NYC Abort Switch  
     examples 59  
     programming 59

## O

obscuration 110  
 Operating parameters, to change. See Status Change  
 Output circuit 110

## P

Panel Circuit 110  
 Panel sounder 110  
 PAS Inhibit switch 80  
 Password  
     Program Change (high level) 13  
     Status Change (low level) 13, 46  
     to change 26  
     to enter 13  
 Point 110  
 Point, to disable/enable 47  
 Poll, see FlashScan™ Poll, CLIP Poll  
 Pre-Alarm 88  
     Action Functions 88  
     Alert Level 88  
     to select a level 89  
     to select sensitivity 90  
 Pre-Alarm, special zone 20, 29, 31  
 Presignal Delay Timer/PAS 20, 29, 30, 80  
 Program Change 14–45  
 Program Errors, check for 41

## R

Release Audible Circuit  
     control module configuration example 75  
     to program 75  
 Release Circuit  
     control module configuration example 73  
     to program 73  
 Release Code Bell Circuit  
     NAC configuration example 77  
     to program 77  
 Release End Bell Circuit  
     control module configuration example 71  
 Release End Bell Circuit, to program 71  
 Release Form-C Circuit  
     control module configuration example 74  
     to program 74  
 Releasing Applications 53–78  
 Releasing Zones (R0-R9) 15, 20, 29, 30, 53  
     type codes for inputs/outputs 65  
 RemT operating mode 32

**S**

- Second Shot Switch 70
  - monitor module configuration example
- Self-Optimizing Pre-Alarm 86
- Sensitivity level for detector 46, 48
- Silence Inhibit Timer 32, 110
- SLC (Signaling Line Circuit) 110
- Smoothing 84
- Soak Timer 29, 30, 53
  - to program (NFPA 16 applications only) 64
- Software Zone 110
- Special Function, See Special Zones
- Special Zone Outputs 80–82
- Special Zones F0-F9 15, 29
  - Special Zone F0, notes and restrictions 80
- status banner 110
- Status Change 46–52
  - Options 46
- Strobes, See System Sensor Strobes, special zone
- Style 4 network setting 42
- Style 4 SLC wiring, global setting 32
- Style 6 SLC wiring, global setting 32
- Style 7 network setting 42
- Supplemental Documentation 11
- Switch Inhibit 110
- System clock 46
- System Message, custom 15, 20, 27
- SYSTEM NORMAL message 20
- System Sensor Strobes, special zone 29, 82

**T**

- Temporal Code 29, 82
- Terminal Mode 110
- Terminal mode supervision enable 32
- Threshold Ch.A/B 42
- Time
  - to set time/date for system clock 46, 49
    - USA or European 32
- Time control, special zones 20, 29, 30, 81
- Time Delay Functions 98
- TM-4 33, 81
- Trouble reminder 43
- Two-Stage 29
- Two-Stage Canada code 82
- Two-stage code 82
- Type Code
  - for releasing zone inputs/outputs 65
- Type Codes 103–107, 110
  - explanation 103
  - for Control Modules 106
  - for Intelligent Detectors 104
  - for Monitor Modules 105
  - for NACs and Panel Circuits 107
  - to select 103

**U**

- UDACT 33

- ULC Release Circuit
  - control module configuration example 72
  - to program 72
- ULI Abort Switch
  - example 56
  - to program 56
- Utility Program 14, 43

**V**

- VeriFire™ Tools 12, 95, 96, 111

**W**

- Walk Test 46, 111
- Walk Test Activation Indications 51
- Walk Test, Advanced 51
- Walk Test, Basic
  - audible 50
  - silent 50
  - trouble 50
- Warning
  - Definition 9
  - Disabling a zone... 47
  - If you replace any detector with a different type... 101
    - Walk Test mode can deactivate fire protection... 50
    - When used for CO2 releasing applications... 53
- Warning Sounders, releasing applications 78

**Z**

- Zones
  - Custom label 15, 28
  - Software Zones 01-99 20
    - to disable programmed points 46
  - Z00 general alarm 20, 24, 41, 82, 89, 95

## Limited Warranty

**NOTIFIER®** warrants its products to be free from defects in materials and workmanship for eighteen (18) months from the date of manufacture, under normal use and service. Products are date stamped at time of manufacture. The sole and exclusive obligation of **NOTIFIER®** is to repair or replace, at its option, free of charge for parts and labor, any part which is defective in materials or workmanship under normal use and service. For products not under **NOTIFIER®** manufacturing date-stamp control, the warranty is eighteen (18) months from date of original purchase by **NOTIFIER®**'s distributor unless the installation instructions or catalog sets forth a shorter period, in which case the shorter period shall apply. This warranty is void if the product is altered, repaired or serviced by anyone other than **NOTIFIER®** or its authorized distributors or if there is a failure to maintain the products and systems in which they operate in a proper and workable manner. In case of defect, secure a Return Material Authorization form from our customer service department. Return product, transportation prepaid, to **NOTIFIER®**, 12 Clintonville Road, Northford, Connecticut 06472-1653.

This writing constitutes the only warranty made by **NOTIFIER®** with respect to its products. **NOTIFIER®** does not represent that its products will prevent any loss by fire or otherwise, or that its products will in all cases provide the protection for which they are installed or intended. Buyer acknowledges that **NOTIFIER®** is not an insurer and assumes no risk for loss or damages or the cost of any inconvenience, transportation, damage, misuse, abuse, accident or similar incident.

**NOTIFIER®** GIVES NO WARRANTY, EXPRESSED OR IMPLIED, OF MERCHANTABILITY, FITNESS FOR ANY PARTICULAR PURPOSE, OR OTHERWISE WHICH EXTEND BEYOND THE DESCRIPTION ON THE FACE HEREOF. UNDER NO CIRCUMSTANCES SHALL **NOTIFIER®** BE LIABLE FOR ANY LOSS OF OR DAMAGE TO PROPERTY, DIRECT, INCIDENTAL OR CONSEQUENTIAL, ARISING OUT OF THE USE OF, OR INABILITY TO USE **NOTIFIER®** PRODUCTS. FURTHERMORE, **NOTIFIER®** SHALL NOT BE LIABLE FOR ANY PERSONAL INJURY OR DEATH WHICH MAY ARISE IN THE COURSE OF, OR AS A RESULT OF, PERSONAL, COMMERCIAL OR INDUSTRIAL USE OF ITS PRODUCTS.

This warranty replaces all previous warranties and is the only warranty made by **NOTIFIER®**. No increase or alteration, written or verbal, of the obligation of this warranty is authorized.

"**NOTIFIER**" is a registered trademark.

Warn-NL-10-2001.fm



World Headquarters  
12 Clintonville Road  
Northford, CT 06472-1653 USA  
203-484-7161  
fax 203-484-7118

[www.notifier.com](http://www.notifier.com)

NOTIFIER is a **Honeywell** company.

**ISO 9001**  
**CERTIFIED**  
ENGINEERING & MANUFACTURING  
QUALITY SYSTEMS